



**ELECTRIC COMBI WALL BOILER
FOR HEATING AND SANITARY HOT WATER PRODUCTION
INSTANTANEOUS WITH ACCUMULATION TANK
Combi **Elektra Compact**.. **BP-L** 016 series**



USER AND MAINTENANCE MANUAL



EQUIPMENT CONFORM TO EC DIRECTIVE 200 6/95/EC. And built in compliance with IEC 60335-2-21:
2012 IEC 60335-1: 2010 EN 60335-2-21: 2003 + A1: 2005 + A2: 2008 - EN 60335-1: 2012 - EN 62233: 2008



ELECTRIC WALL BOILER

Series ELEKTRA Compact.. BP-L 016

Presentation

*Thank you for choosing an electric wall boiler FIAMMA, built with the most modern technologies, safe and tough materials, so as to ensure maximum efficiency of use, total quality of the device and extreme safety for user. The series **Elektra..** is built according to European standards dir. machines 2006/42 - IEC 60335-1:2010 with EN 60335-2-21:2003 +A1:2005+A2:2008 - EN 60335-1:2012 - EN 62233:2008.*

The obtained results can be summarized in the following key points:

- noiseless functioning, thanks to maximum insulation of the device by means of innovative special materials that ensures minimum heat loss.*
- high degree of reliability, thanks to a careful choice of materials and to server tests carried out during production for each unit built.*
- high performance with maximum efficiency, thanks to a modulation of electric power to the heating elements, according to the actual need of energy by the system or the need of sanitary water. The system D.E.S. manages the device with temperature probes positioned in each sensitive point of the boiler, so as to manage both comfort and economy functioning, in order to reduce power consumption when the device is not used at the maximum capacity or demand.*
- the appliance is fully adjustable both in water temperature of the heating system (with the possibility to choice of system at high and low temperature for the underfloor systems) and in the domestic hot water temperature.*
- The assembly of the components has been realized in order to allow an easy access to them, all from the front of the unit, for ordinary and extraordinary maintenance.*

We recommend you to follow our instructions, and we suggest to contact the area authorized service FIAMMA in order to prepare a planned maintenance contract which can ensure suitable operation at maximum efficiency and safety, so that your machine use can go a long way. In renewing our thanks, our technical department and our sales network, are at your disposal for any further information.

FIAMMA GIRO s.r.l.
Company group



*The company **FIAMMA GIRO s.r.l.** declines all responsibility for possible inaccuracies contained in this pamphlet, if due to printing errors or inadvertent errors. However, reserves the right to make changes to its products that it deems useful or necessary, without affecting the essential characteristics of the products manufactured and marketed.*



WARNINGS:



THIS EQUIPMENT MAY BE USED BY CHILDREN FROM 8 YEARS AND UP TO PERSONS WITH CAPACITY PHYSICAL, SENSORY OR MENTAL CAPABILITIES OR LACK OF EXPERIENCE AND KNOWLEDGE, A CONDITION THAT SUPERVISION OR WHO WILL GET DIRECTIONS FOR USE IN THE DEVICE SAFELY TO UNDERSTAND THE RISKS INVOLVED. CHILDREN SHOULD NOT PLAY WITH THE APPLIANCE. CLEANING AND MAINTENANCE SHOULD NOT BE MADE BY CHILDREN WITHOUT SUPERVISION.



FOR DIRECT CONNECTION TO THE MAINS, YOU MUST PROVIDE A DEVICE THAT MAKE THE DISCONNECT THE NETWORK WITH A DISTANCE CONTACT OPENING ALLOWING THE COMPLETE DISCONNECT THE CONDITIONS OF OVERVOLTAGE CATEGORY III, UNDER THE RULES OF INSTALLATION.



IF THE POWER CABLE IS DAMAGED, IT MUST BE REPLACED BY THE MANUFACTURER OR THE TECHNICAL ASSISTANCE SERVICE OR OTHERWISE BY A PERSON WITH SIMILAR QUALIFICATION IN ORDER TO PREVENT ANY RISK.



WATER CAN DRIP FROM EXHAUST DEVICE AGAINST OVERPRESSURE AND THE HOSE MUST BE LEFT OPEN THE ATMOSPHERE.



THE DEVICE AGAINST OVERPRESSURE SHALL BE OPERATED REGULARLY TO REMOVE DEPOSITS OF LIMESTONE AND TO CHECK THAT ARE BLOCKED.



THE EXHAUST PIPE CONNECTED TO THE DEVICE AGAINST OVERPRESSURE MUST BE INSTALLED IN SLOPE AND CONTINUE DOWN IN A PROTECTED BY ICE FORMATION.



DIMENSIONS

The series **Elektra Compact.. BP-L 016** has four power levels, but the same overall dimensions:

Elektra Compact 6 kW BP-L 016 6 kW maximum electrical output

Elektra Compact 12 kW BP-L 016 12 kW maximum electrical output

Elektra Compact 18 kW BP-L 016 18 kW maximum electrical output

Elektra Compact 24 kW BP-L 016 24 kW maximum electrical output

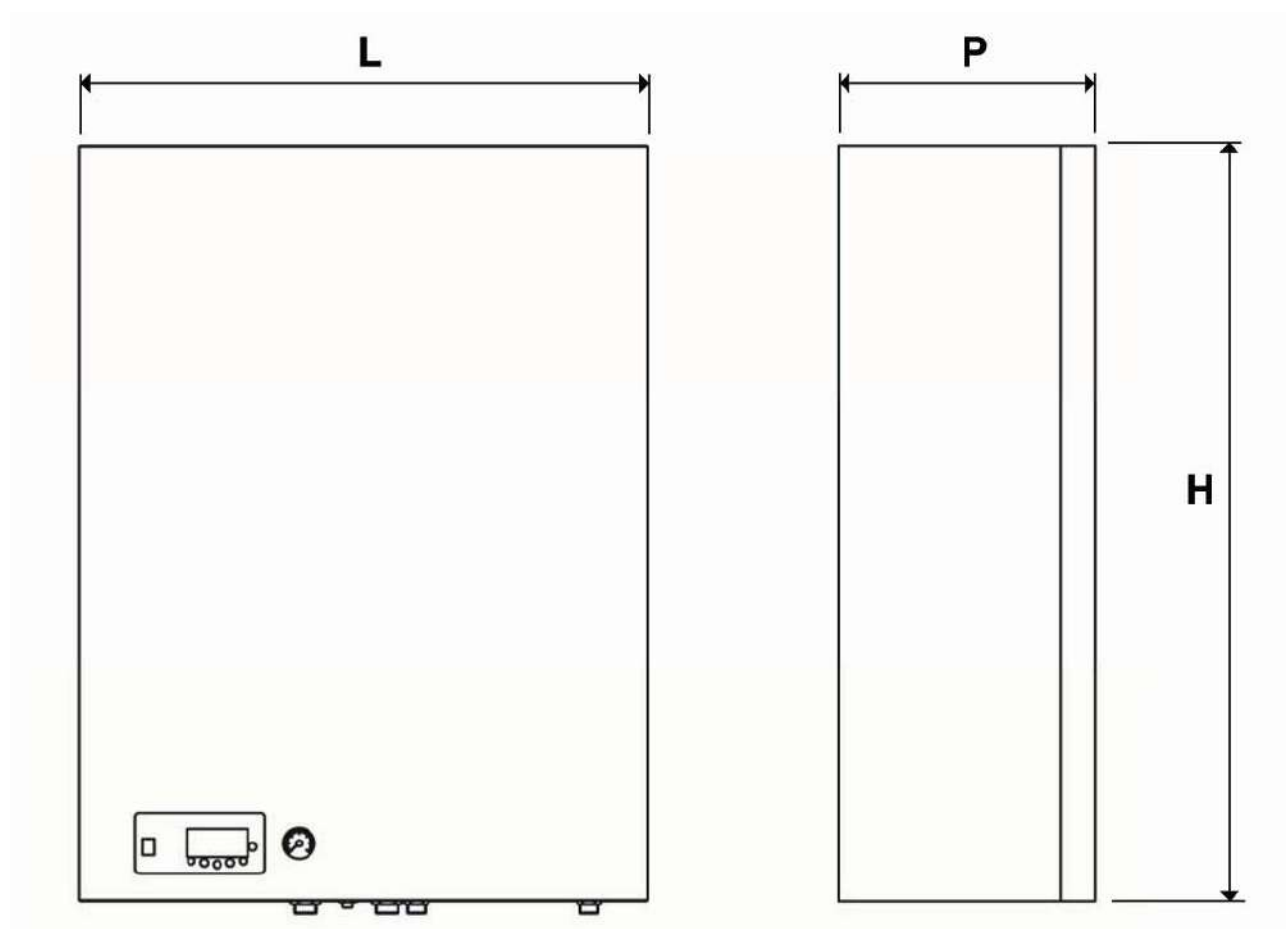

Appliance dimension:

L (Width): 660 mm

H (Height): 875 mm

P (Depth): 300 mm

Weight: 59 kg

Packaging dimensions:

Width: 710 mm

Height: 940 mm

Depth: 390 mm

Weight: 62,5 kg



Hydraulic connections - Dimensional of connection arrangement

M	Heating delivery:	3/4"	M
R	Heating return:	3/4"	M
AF	Cold sanitary water inlet:	1/2"	M
AC	Hot sanitary water output:	1/2"	M
VSR	Heating safety valve (0,3 MPa - 3 bar):	1/2"	F
VSS	Sanitary safety valve (0,65 MPa - 6,5 bar):	1/2"	F

The unit is expected to be connected in a continuous manner to the water mains with out the use of a set of junctions.

Bottom view (under the boiler)

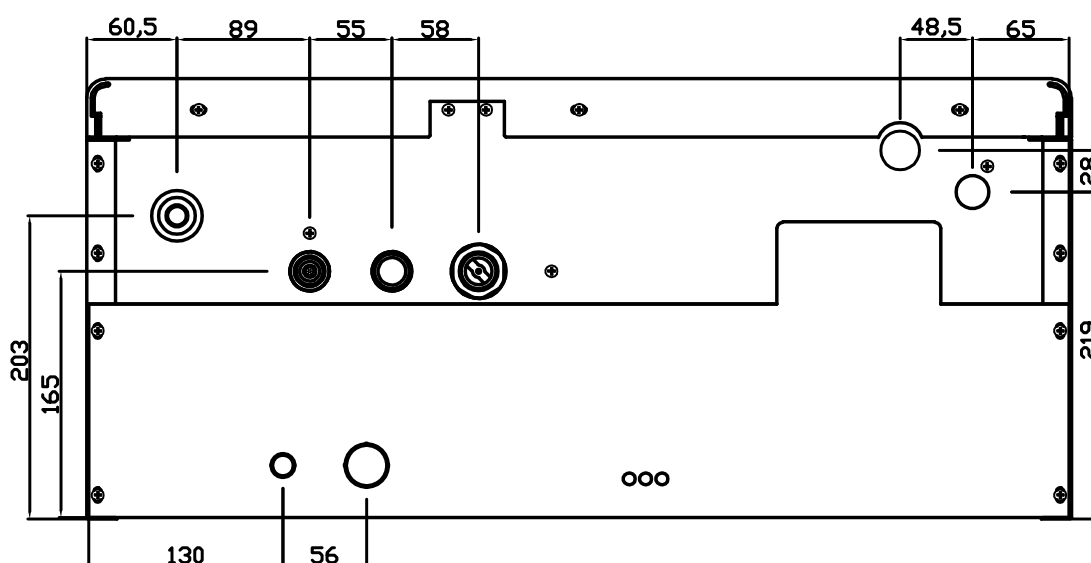
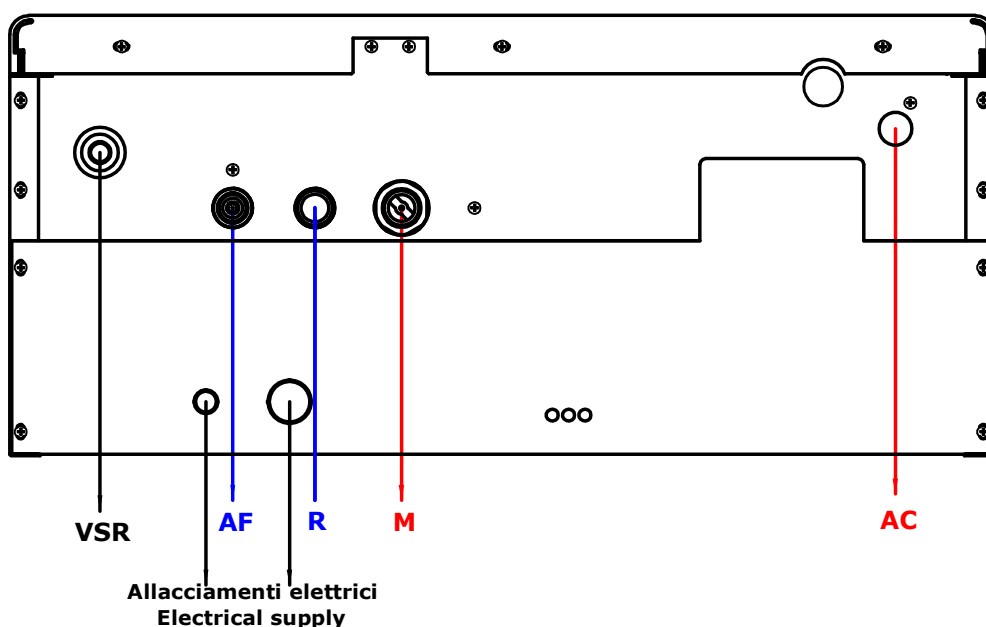



MAIN TECHNICAL FEATURES

Elektra Compact 6 kW BP-L 016 6 kW maximum electrical output

Single-phase electrical supply: 230-240 V - 50 Hz.

Weight: 58 kg.

Capacity of tank 37 liters. Glass-lined steel with inspection flange and magnesium anode.

Electrical / heat power available at heating of 6 kW obtained by n°.2

Resistance group (n°.2 da 3x1 kW).

Electrical power at hot water resistance of 2 kW (2.000 W).

Maximum head available at the pump of 7 m.c.a.

Expansion vessel capacity of 9 liters.

Safety valve of heating circuit of 0,3 MPa (3 bar).

Safety valve of sanitary circuit of 0,65 MPa (6,5 bar).

Maximum heating operating pressure: 0,25 MPa (2,5 bar).

Maximum sanitary operating pressure: 0,55 MPa (5,5 bar).

Minimum operating pressure in the heating circuit: 0,06 MPa (0,6 bar).

Mini. operating pressure in the sanitary, comfort system: 0,025 MPa (0,25 bar).

Min. operating pressure in the sanitary, economy system: 0,005 MPa (0,05 bar).

Maximum limit of thermal safety heating circuit - boiler body: 100°C.

Elektra Compact 12 kW BP-L 016 12 kW maximum electrical output

Single-phase electrical supply: 230-240 V - 50 Hz.

Weight: 59 kg.

Capacity of tank 37 liters. Glass-lined steel with inspection flange and magnesium anode.

Electrical / heat power available at heating of 12 kW obtained by n°.2

Resistance group (n°.2 da 3x2 kW).

Electrical power at hot water resistance of 2 kW (2.000 W).

Maximum head available at the pump of 7 m.c.a.

Expansion vessel capacity of 9 liters.

Safety valve of heating circuit of 0,3 MPa (3 bar).

Safety valve of sanitary circuit of 0,65 MPa (6,5 bar).

Maximum heating operating pressure: 0,25 MPa (2,5 bar).

Maximum sanitary operating pressure: 0,55 MPa (5,5 bar).

Minimum operating pressure in the heating circuit: 0,06 MPa (0,6 bar).

Mini. operating pressure in the sanitary, comfort system: 0,025 MPa (0,25 bar).

Min. operating pressure in the sanitary, economy system: 0,005 MPa (0,05 bar).

Maximum limit of thermal safety heating circuit - boiler body: 100°C.



Elektra Compact 18 kW BP-L 016 18 kW maximum electrical output

Single-phase electrical supply: 230-240 V - 50 Hz.

Weight: 60 kg.

Capacity of tank 37 liters. Glass-lined steel with inspection flange and magnesium anode.

Electrical / heat power available at heating of 18 kW obtained by n°.3

Resistance group (n°.3 da 3x2 kW).

Electrical power at hot water resistance of 2 kW (2.000 W).

Maximum head available at the pump of 7 m.c.a.

Expansion vessel capacity of 9 liters.

Safety valve of heating circuit of 0,3 MPa (3 bar).

Safety valve of sanitary circuit of 0,65 MPa (6,5 bar).

Maximum heating operating pressure: 0,25 MPa (2,5 bar).

Maximum sanitary operating pressure: 0,55 MPa (5,5 bar).

Minimum operating pressure in the heating circuit: 0,06 MPa (0,6 bar).

Mini. operating pressure in the sanitary, comfort system: 0,025 MPa (0,25 bar).

Min. op rating pressure in the sanitary, economy system: 0,005 MPa (0,05 bar).

Maximum limit of thermal safety heating circuit - boiler body: 100°C.

Elektra Compact 24 kW BP-L 016 24 kW maximum electrical output

Single-phase electrical supply: 230-240 V - 50 Hz.

Weight: 61 kg.

Capacity of tank 37 liters. Glass-lined steel with inspection flange and magnesium anode.

Electrical / heat power available at heating of 24 kW obtained by n°.4

Resistance group (n°.4 da 3x2 kW).

Electrical power at hot water resistance of 2 kW (2.000 W).

Maximum head available at the pump of 7 m.c.a.

Expansion vessel capacity of 10 liters.

Safety valve of heating circuit of 0,3 MPa (3 bar).

Safety valve of sanitary circuit of 0,65 MPa (6,5 bar).

Maximum heating operating pressure: 0,25 MPa (2,5 bar).

Maximum sanitary operating pressure: 0,55 MPa (5,5 bar).

Minimum operating pressure in the heating circuit: 0,06 MPa (0,6 bar).

Mini. operating pressure in the sanitary, comfort system: 0,025 MPa (0,25 bar).

Min. op rating pressure in the sanitary, economy system: 0,005 MPa (0,05 bar).

Maximum limit of thermal safety heating circuit - boiler body: 100°C.



POSITIONING THE BOILER

The appliance must be installed exclusively on a vertical and solid wall that can support the weight of the boiler through the support bracket placed supplied in the box packaging.

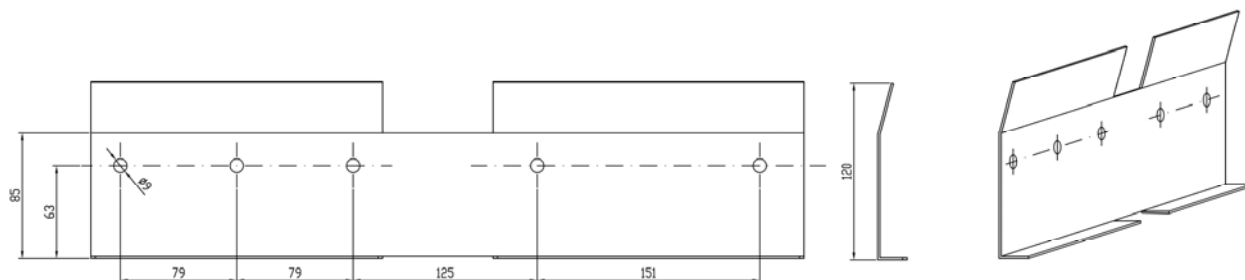

The bracket must be fixed to the wall with five M8 screws with appropriate anchors conform to the type of the wall itself (not in the boiler kit). The device is attached at the top by bringing the folded portion of the bracket in the chassis through the boiler behind the unit.



CONTROL PANEL

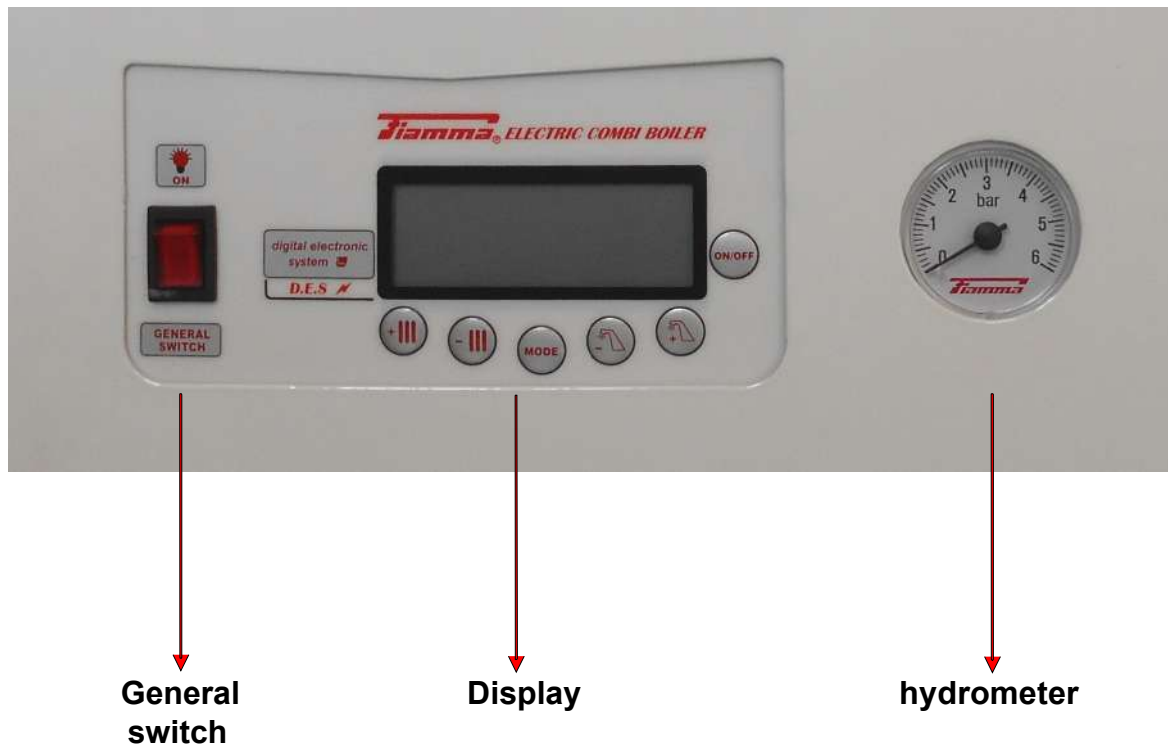

The control panel is composed of: display, function selection keys, general switch and the hydrometer it is placed in the lower left corner in front of the unit (see image above).

Using analogical hydrometer

The analogical hydrometer control panel has a dial with unit of measure in a bar, by 0 to 6 bar. The water pressure in the heating system is indicated by the index of the black arrow. The optimum pressure for the system is between 1 and 1,5 bar.

More than 1,5 bar you can have a maximum pressure of the 2 bar (maximum expansion of the system during the rise in temperature). More than 2 bar pressure the system is not in the range of operation, and the mechanical safety valve (preset to 3 bar) can start to lose water (to access the valves remove the knockout openings at the valves, see page 2 hydraulic installation diagram).

The minimum operating pressure is 0,8 bar (+/-0,2 bar). The differential positive or negative tolerance is due to the operation of the water pressure switch with fixed setting.



Keyboard panel (Control panel)

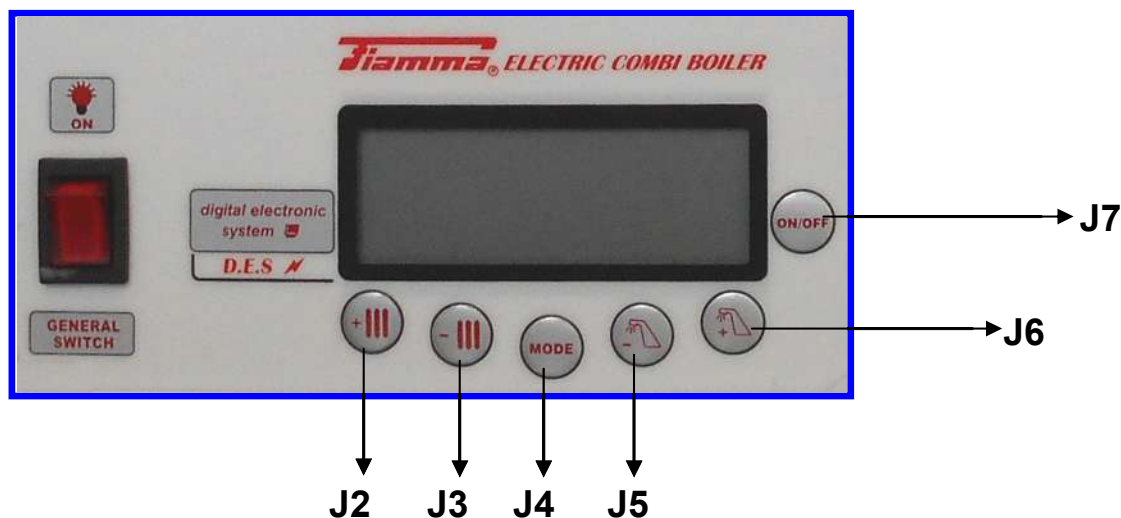

Meaning of the keys in user mode

Key	Function
-⌂ (J5)	Display / Tank setpoint decrease
+⌂ (J6)	Display / Tank setpoint increase
ON/OFF (J7)	- ON - OFF switching (long press) - Display temperature output / Display setpoint output - Unlock error of safety thermostat
MODE (J4)	Summer – winter switching (long press)
+ (J2)	Display / Increase of heating setpoint (or room temperature)
- (J3)	Display / Decrease of heating setpoint (or room temperature)
-⌂ + +⌂ (J5 + J6)	Enabling function Eco/Comfort (only if JP8 = 0 and P8 = 0)
MODE + ON/OFF (J4 + J7)	Start function degassing



TURNING ON THE BOILER

The boiler is switched-on by means of the general switch located on the left of the display in the instrument panel of the boiler. Pressing the switch upward to the ON position, it will light in the presence of single-phase supply (230-240 V - 50 Hz). Then, it shall be pressed the **ON-OFF (J7)** on the keypad to switch the power from stand-by to the operating position, the display will light up of blue and will appear various symbols signaling function/faults etc. At this point it shall be chosen the mode of operation, summer or winter operation.

CHOICE OF THE OPERATION MODE (Winter/Summer)

Pressing the key **MODE (J4)**, it will be chosen the mode of operation, wintry or summery. Pressing repeatedly each time for at least 5 seconds, you switch from WINTER to SUMMER or from SUMMER to WINTER then.

When the device will be in WINTER mode, on the display will appear the Symbol ❄️ (snow). When the device will be in SUMMER mode, on the display will appear the Symbol ☀️ (sun).

TEMPERATURE VARIATION OF THE HEATING CIRCUIT

When the apparatus has been set with the snow symbol (❄️) for the wintry functioning, you can change the maximum temperature of heating circuit pressing one of the two keys with the radiator symbol located on the left of the display (+ III and - III keys). The key with the symbol + III (J2), increases the temperature, and the key with the symbol - III (J3) decreases the temperature.

TEMPERATURE VARIATION OF HOT SANITARY WATER

The temperature of hot sanitary water can be varied independently from the mode of functioning, both wintry and summery. The two keys with the Tap symbol on the left of the control panel, are used to set the maximum temperature of the hot sanitary water circuit. The key with Symbol + 🚰 (J6) increases the temperature, and the one with the Symbol - 🚰 (J5) decreases the temperature.



ON-OFF KEY

Display symbols

The **ON/OFF (J7)** key, in addition to put the boiler in stand-by mode, allows to reset (unlock) the apparatus in case of high temperature lock.

If the lock would be caused by lack of water pressure alarm, the recovery will be automatic

after that the hydric pressure will be restored at the minimum operating level (0,08 MPa - 0,8 bar) by means of the operating and the closure of the charging tap placed under the boiler (black handle). The display has several symbols, signaling in addition to operation modes, also the various alarm or system displays:

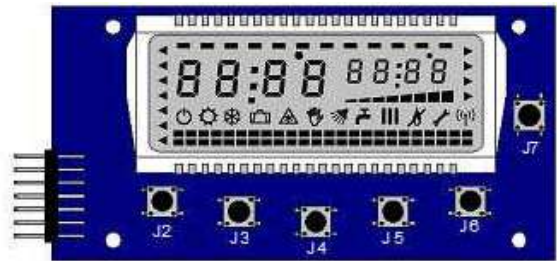

Symbol	Meaning
	Malfunction
	Request of burner switch-on
	Heating request
	Sanitary request (generic)
	Function sanitary Comfort activated
	Parameter menu activated
	Anti-freeze request activated
	Winter mode
	Summer mode
	OFF mode
Level of modulation	Indicates the instantaneous power of the boiler by 0 to 100%



INSTALLATION TECHNICAL NOTE FOR INSTALLER AND TECHNICAL MAINTENANCE

HYDRAULIC SCHEME (Elektra Compact 12 kW BP-L 016 version)

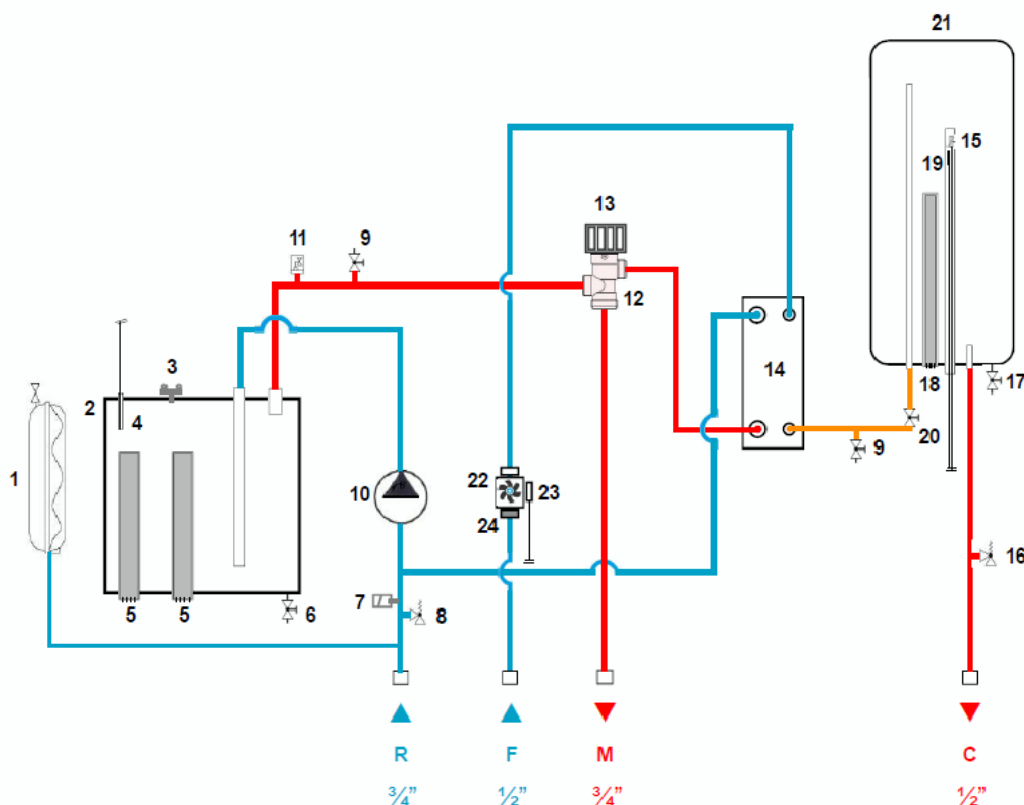

LEGEND HYDRAULIC SCHEME	
1	Vessel (expansion vase) x heating plant (lt.9).
2	Body electric boiler 6-9-12 kW.
3	Safety thermostat 100°C.
4	Heating water temperature probe.
5	Electrical resistance. 3x2 (or 3x1) kW - 230V/50Hz.
6	Drain tap for boiler body.
7	Water pressure switch 0.6 bar.
8	Safety valve 3 bar (heating).
9	Drain tap (for air vent).
10	Electronic pump.
11	Jolly (automatic air vent).
12	Electric diverter valve (3-way).
13	Actuator (motor) diverter valve.
14	Stainless steel plate heat exchanger.
15	Tank water temperature probe (ntc).
16	Safety valve 6,5 bar (DHW).
17	Drain tap tank.
18	Ceramic Resistance 2000 W.
19	Probe of safety DHW thermostat.
20	DHW flow regulator tap.
21	Vitrified storage tank 37 lt.
22	Sanitary flowmeter (DHW).
23	Probe for Sanitary flowmeter.
24	Cold water inlet filter.
R	Return (heating).
F	Inlet DHW.
M	Heating system delivery.
C	Outlet DHW.
Technical study - via L. Landucci 2 - 21. 51100 - PISTOIA - TEL. 0573.532812 e-mail: servizi@elettronici.fiammagiro.it	
Date: 2019/01/01 Scale: ---- Designer: Gino Lucini Commit to: Gino Lucini	SUBJECT: Hydraulic Scheme for electric boiler ELEKTRA COMPACT BP-L series 6-9-12 kW.

For the other models, the only changes refer to the number of electric resistances; the 6 kW version has two 3 kW resistances (detail RC), the 12 kW version has two 6 kW resistances, the 18 kW version has three 6 kW resistances and the 24 kW version has four 6 kW resistances.



CONNECTING SCHEME

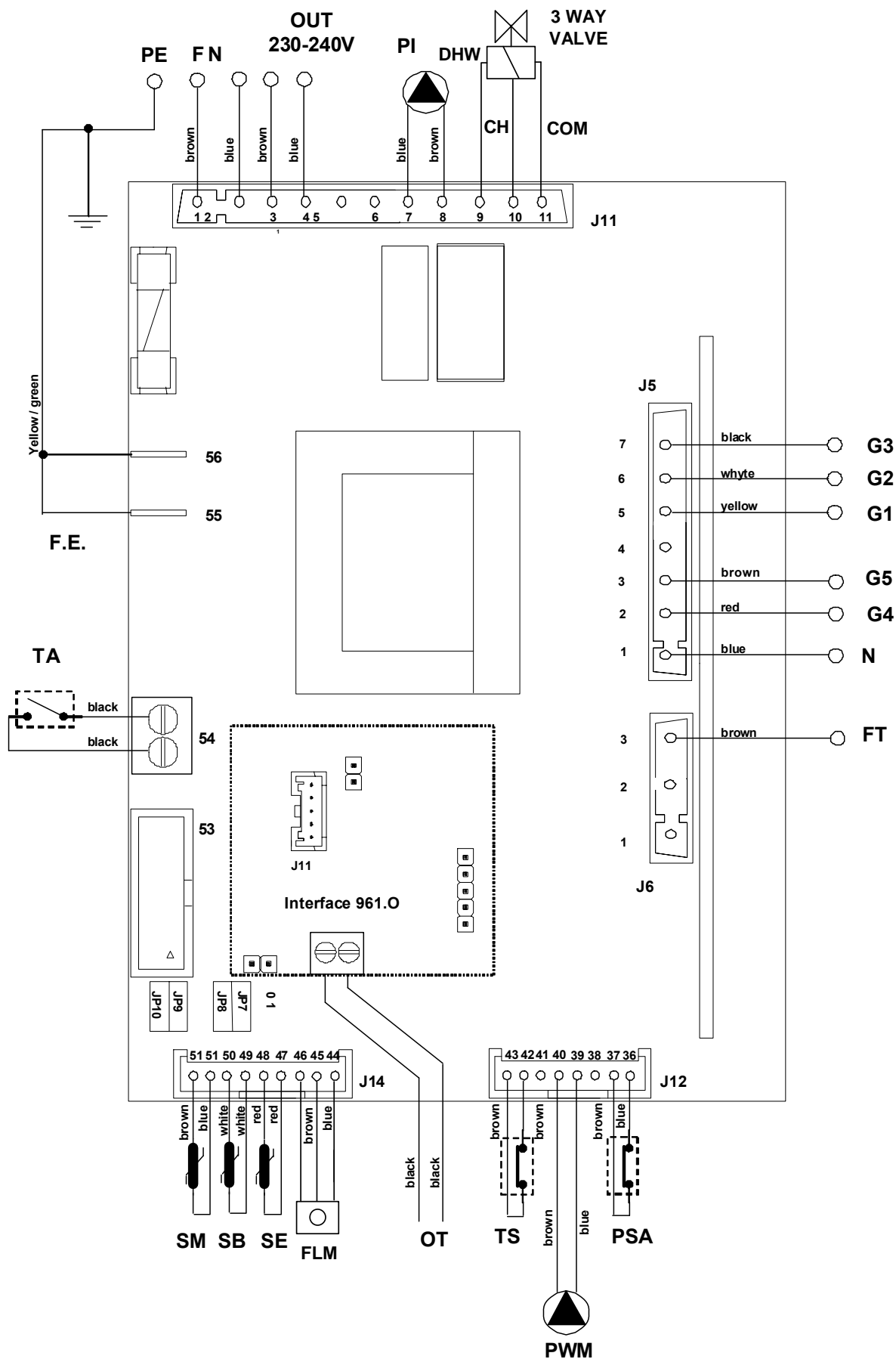



MAIN ELECTRIC SCHEME

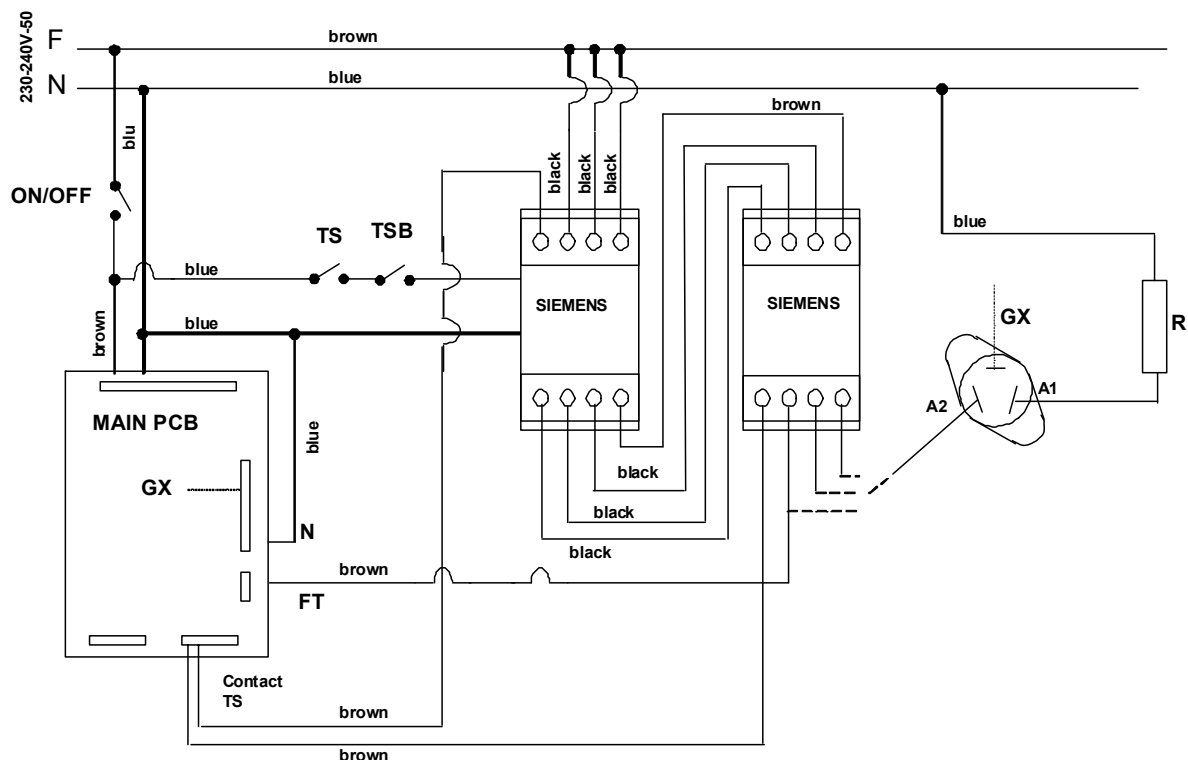

Legend electric scheme

Single phase	F
Neutral	N
Selected phase from contactor	FT
Electric pump (circulator variable prevalence)	PI
Control of contact TS on contactor of power (C-NO)	cTS
Sanitary microswitch (control Comfort function)	MS
Control gate triac n°1 (4 KW power)	G1
Control gate triac n°2 (2 KW power)	G2
Control gate triac n°3 (4 KW power)	G3
Control gate triac n°4 (2 KW power)	G4
Control gate triac n°5 (2 KW sanitary tank)	G5
Delivery heating probe (ntc sensor)	SM
External probe (sensor)	SE
Sanitary probe (tank)	SB
Water pressure switch	PSA
Safety thermostat	TS
Safety thermostat tank	TSB
Room thermostat (terminal provided)	TA
Connection with remote control OpenTherm (optional)	OT
General switch (Also disconnects power to the board)	ON/OFF
Functional ground derived from the point ground	F.E.
Properly grounded point this application	PE



TRIAC – Connection scheme

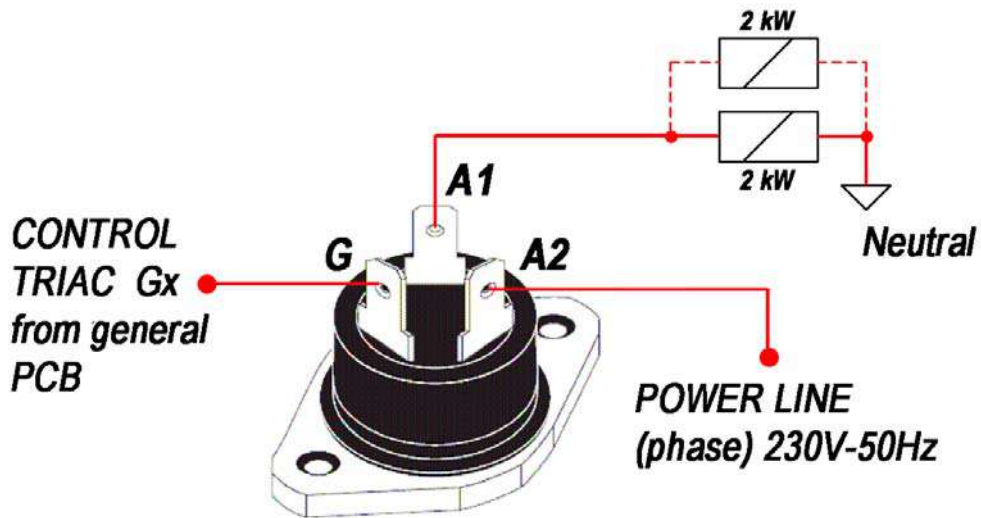

WHITE electric wire from 6 point J5 plug	GATE G2	TRIAC 2 (2 kW)	BLACK electric wire 2,5 mmq section ϕ
BLACK electric wire from 7 point J5 plug	GATE G3	TRIAC 3 (4 kW)	BLACK electric wire 4 mmq section ϕ
RED electric wire from 2 point J5 plug	GATE G4	TRIAC 4 (2 kW)	BLACK electric wire 2,5 mmq section ϕ
BROWN electric wire from 3 point J5 plug	GATE G5	TRIAC 5 (2 kW) Sanitary Tank	BLACK electric wire 2,5 mmq section ϕ
YELLOW electric wire from 5 point J5 plug	GATE G1	TRIAC 1 (4 kW)	BLACK electric wire 4 mmq section ϕ



MANUFACTURE CONSTANTS

Function	Value
Delta off tank probe	0 °C
Delta on tank probe	-1 °C
Intervention temperature antilegionella	65 °C
Intervention interval antilegionella	7 days
Maximum temperature primary circuit	80 °C
Time of pump functioning in anti-lock	10 sec
Intervention time anti-lock pump	24 hour
Temperature antifreeze On (only circulator)	< 8 °C
Temperature antifreeze On (heat exchanger ignition)	< 5 °C
Temperature antifreeze Off	> 20 °C

SETPOINT AND PARAMETERS

Function	Default	Range
Heating setpoint	60 °C	30 ÷ 75 °C
Floor heating setpoint	30 °C	10 ÷ 40 °C
Room setpoint (with external probe present)	20 °C	10 ÷ 30 °C
Tank setpoint	60 °C	30 ÷ 65 °C
Instantaneous DHW setpoint	50 °C	30 ÷ 60 °C

PARAMETERS

Function	Display	Def.	Range
External probe start up	P : 1	0	0 – 1
Building coefficient of dispersion	P : 2	35	5 ÷ 35 °C
Sanitary post circulation	P : 3	15	1 ÷ 180 sec
Heating post circulation	P : 4	30	1 ÷ 180 sec
Heating exchanger circulation starting	P : 5	0	0 ÷ 240 sec
Min. ignition temperature circulator	P : 6	30	0 ÷ 50 °C
Delivery differential of sanitary	P : 7	15	0 ÷ 20 °C
Type kettle present	P : 8	0	0 = Internal probe 1 = External thermostat 2 = External probe
Type of sensor required tank	P : 9	1	0 = flow switch and three-way pneumatic 1 = flow meter and electric three-way
Speed pump PWM operation	P : 10	4	1 = 400 l/h 2 = 800 l/h 3 = 1.000 l/h 4 = 1.200 l/h



TEMPERATURES

Function	Display
Delivery temperature	t :Ch
Tank temperature	t :dh
External temperature	t :EP
Offset setpoint of external probe	t :SE
Sanitary flow meter flow rate expressed in liters/minute	FL.Πt

SELECTION JUMPERS (move the jumpers with no power board)



Jumper	0	1	Default
JP7	High temperature (radiator)	Low temperature (floor)	0
JP8	Combined	Heating only	0
JP9	Sanitary with tank	Sanitary instantaneous	0
JP10	Boiler application	Scaldamassetto application	0

CONTROL OF MAIN HEAT EXCHANGER (BOILER BODY)

According to the required power during the heat request, the controls by G1 to G4 related to the main exchanger are turned on all or partially. The actuation of each control is reduced to a lapse of 4 seconds. Higher is the required power, more the control will remain operative in this lapse. The power in heating or during a sanitary request is calculated by PID algorithm. Please see in the pictures below two examples related to 40% and 60% of total power (12 kW).

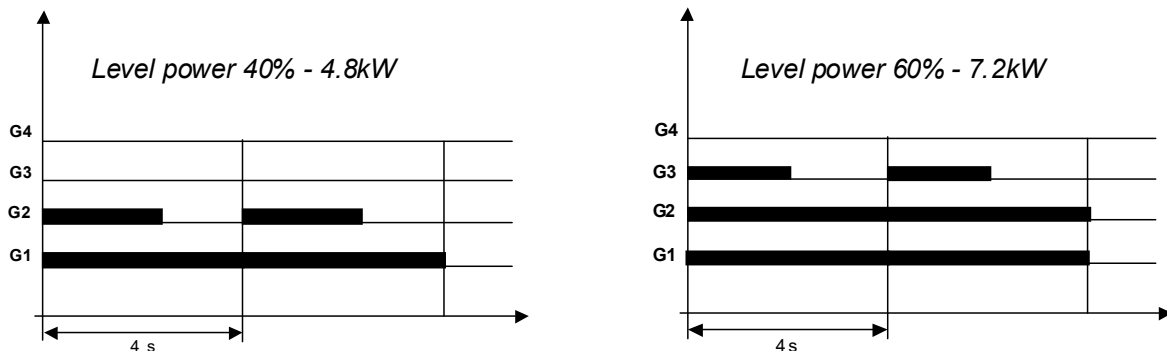

In case of simultaneous request of heating and tank, the controls G1÷G4 related to the main heat exchanger, and G5, dedicated to tank, will be directed in the following way:

Boiler status	Primary G1÷G4	Tank G5
Only heating request	G1 ÷ G4 = modulation	G5 = OFF
Heating request + tank request	G1 ÷ G3 = modulation G4 = OFF	G5 = ON
Heating request + flow switch request	G1 ÷ G3 = modulation G4 = OFF	G5 = ON



Controls rotation

Every hour the order of ignition of triac G1÷G4 controls is rotated in such a way to partition evenly in time the use of all heating elements.

CONTROL OF EXTERNAL PROBE

Installation and functioning at sliding temperature

For the connection of the External Probe, it shall be used the Original Kit FIAMMA code F.532 provided in the accessories of the electric boilers Elektra. The electrical connection shall be done in the external terminal at the general electric panel already prearranged in the standard cabling of the boiler. The connection must be carried out with junction cables and wires having a minimum section of 1,5 mm and, if possible, avoiding the insertion along with electric lines, digital lines of inverter or other not compatible.



After the connection the external probe must be enabled by means of the introduction of a variation of **P1** parameter, changed from 0 to 1.

Then the setpoint chased by the heating delivery probe will be calculated as follows:

$$T_{ch} [^{\circ}\text{C}] = [(T_{room} [^{\circ}\text{C}] - T_{ext} [^{\circ}\text{C}]) * dc/10] + T_{room} [^{\circ}\text{C}]$$

T_{ch} : heating setpoint calculated by the system

T_{room} : ambient temperature set by the user

T_{ext} : outside temperature measured by the probe

dc : dispersion coefficient of the building can be set by parameter **P2**.

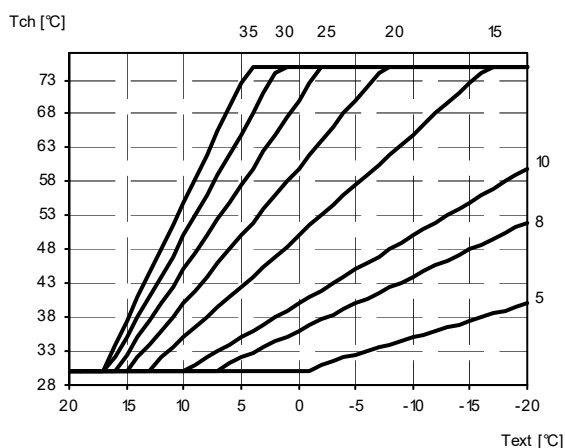

Examples of curves with T_{room} set at 20°C and $JP7 = 0$

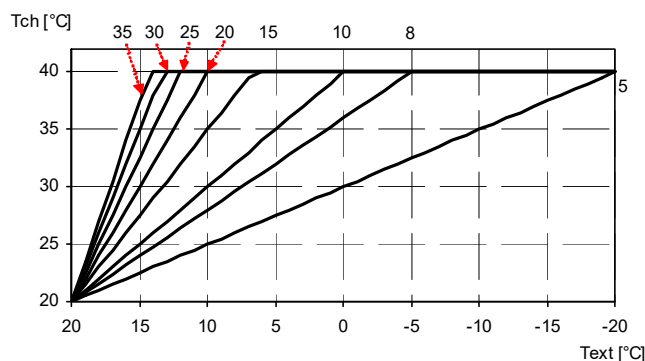

Examples of curves with T_{room} set at 20°C and $JP7 = 1$



ANTIFREEZE FUNCTION

In case the delivery probe measures a temperature lower than 7°C, the circulator is activated. If the temperature goes down the value of 4°C, the primary exchanger (boiler body) is turned on until bringing the outlet temperature to 20°C. The antifreeze function is active also with the boiler turned OFF (function in standby mode but with bright switch on).

TANK REQUEST (JP9 = 0 - P8 = 0)

Standby or with simultaneous heating request:

In this case, if the temperature measured by the tank probe is lower than the tank setpoint -1°C, is activated the control G5 related to the tank resistance. When the temperature at the tank sensor is higher than the boiler setpoint G5 control is turned off. The activation of G5 causes the shutdown of the G2 or G4 (2 kW) in such a way that the maximum total consumption of the system can always be 12 kW.

Sanitary flow meter request:

When receiving a request by the sanitary flow switch, the resistance related G5 control (2 kW) the boiler is activated independently until the storage tank temperature remains below 70°C. In ECO mode is not activated any of the primary exchanger resistance.

In COMFORT mode simultaneously G1 commands are also controlled, G2, G3, G4 relative to the primary exchanger bringing the supply temperature to the boiler setpoint + differential set using parameter P7. At the end of the request, the circulator remains powered for a time equal to the value set by parameter P3.

Pre-heat exchanger primary:

In condition of stand-by with active COMFORT function, the primary exchanger is maintained in temperature in order to ensure a prompt response of sanitary. The main heat exchanger is maintained at a temperature equal to the setpoint plus a kettle temperature difference settable by means of the parameter P7. The maximum power used to manage this phase is 6 kW.

ANTILEGIONELLA FUNCTION

The system continuously monitors the temperature of the kettle. If within a certain time interval the temperature does not reach the value of 65°C, the tank resistance is automatically ignited in order to avoid bacterium growth.

The operating time of the legionella function is 3 hours from the first ignition and then every 7 days.



DHW DEMAND INSTANTANEOUS (jumper JP9 = 1)

When receiving a request by the sanitary flow switch, the circulator is powered and checks the commands G1, G2, G3, G4 relative to the primary exchanger bringing the supply temperature to the DHW set point + differential value set through parameter **P7**. At the end of the request, the circulator remains powered for a time equal to the value set by parameter **P3**.

FUNCTION ECONOMY / COMFORT SANITARY

In ECO mode in the stand-by condition no resistance of the primary exchanger is activated. When it is active the COMFORT function in stand-by conditions the primary exchanger is maintained in temperature in order to ensure a prompt response of sanitary. The main heat exchanger is maintained at a temperature equal to the DHW set point temperature plus a differential adjustable the parameter **P7**.

REQUEST HEATING

At the closing of the room thermostat contact, if the board is in winter mode, the system pump is only activated if the primary exchanger temperature is higher than the set temperature using the parameter **P6**. If the temperature value detected by the primary exchanger probe is lower than the flow temperature setpoint set, the triacs are turned on in sequence according to the power required. This only occurs after a time set by parameter **P5**, to allow for example the opening of eventual zone valves. The instantaneous power of the boiler and the control of the triac G1÷G4 is by PID controller. At the end of the request, the circulator remains powered for a time equal to the value set by parameter **P4**.

DEGASSING FUNCTION

During the degassing function activated by simultaneously pressing the **MODE (J4)** button and **ON / OFF (J7)**. During this function it is alternating operating states of maximum and minimum speed of the circulator PWM in order to facilitate the escape of air bubbles from the hydraulic circuit. The sequence is illustrated below.

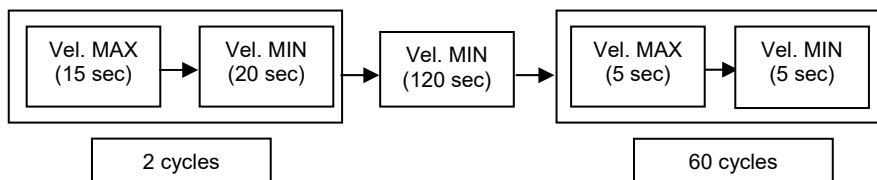

When this function is active the display shows a timer that signals the time for the end of the function.



	OPERATING PANEL	CONTROL MODE
0		PWM PROFILE A 1 - SIGNAL OFF
		PWM PROFILE A 1 - PWM SIGNAL ON
		PWM PROFILE A 2 - SIGNAL OFF
		PWM PROFILE A 2 - PWM SIGNAL ON
1		PWM PROFILE A 3 - SIGNAL OFF
		PWM PROFILE A 3 - PWM SIGNAL ON
		PWM PROFILE A 2 - SIGNAL OFF
		PWM PROFILE A 2 - PWM SIGNAL ON
2		PWM PROFILE A 3 - SIGNAL OFF
		PWM PROFILE A 3 - PWM SIGNAL ON
		PWM PROFILE A 2 - SIGNAL OFF
		PWM PROFILE A 2 - PWM SIGNAL ON

FLASH INDICATION	
	1 FLASH PER SECOND
	8 FLASHES PER SECOND

ALARM STATUS	FAULT
	BLOCKED
	LOW VOLTAGE
	ELECTRICAL ERROR

The new FLEX-AS (K) 2020 version pump, is equipped with three speeds that can be manually set, and 4 flow reductions (with speed lowering) via the PWM signal, which can be set from the boiler control display panel. In total, ten circulator speeds can be set with relative ten distinct flows.

Pump programming

Manually select the maximum speed profile on key , then using the boiler control panel, select parameter 10 and choose one of the four available flows for each speed, setting values from 1 to 4. Set value 1 for the minimum flow, or 4 for the maximum flow, set 2 and / or 3 for the intermediate flow rates. According to the scheme of the table above, for each speed, the maximum value is represented by the Led that flashes once per second (parameter 10 setting to value 4), when the pwm programming intervenes, from value 3 to 1, the green Led flashes with a frequency of 8 flashes / second. The maximum speed is indicated by the first yellow Led under the III sign, the intermediate speed by the second yellow LED positioned under the II symbol, and the first speed is indicated by the third yellow LED under the I symbol (front view, from left to right).

ANTI-LOCK CIRCULATOR

If the circulator, has not performed any operation cycle in a period of time of 24 hours, it is activated for 10 seconds, in order to avoid long idle block. At the end of the post-circulation phase, activated following a request for domestic hot water, the electric diverter valve is powered for 2 seconds to avoid blocking for long periods of inactivity.

MEANING OF THE KEYS OF TEMPERATURE MENU

To log in temperature menu, press simultaneously (J3) and (J5) keys. The symbol will appear on the display.

Key	Function
ON/OFF (J7)	Exit by temperature menu
+III (J2)	Temperature index increase
-III (J3)	Temperature index decrease



MEANING OF KEYS OF PARAMETERS MENU

To log in parameter menu, press simultaneously **+III (J2)** and **+⚡ (J6)** keys for 4 seconds.

The symbol  will appear on the display.

Key	Function
-⚡ (J5)	Parameter value decrease
+⚡ (J6)	Parameter value increase
ON/OFF (J7)	Exit by parameters menu
+III (J2)	Parameter index increase
-III (J3)	Parameter index decrease

“Heating elements status”

The dashes located in the upper part indicate the heating elements status. Each dash corresponds to a 2 kw element (with 12 kW application). The first 6 dashes refer to the heating modules of the primary exchanger. The dash on the right upper corner refers to the heating module dedicated to the tank G5 (only if JP8 = 0 and JP9 = 0).

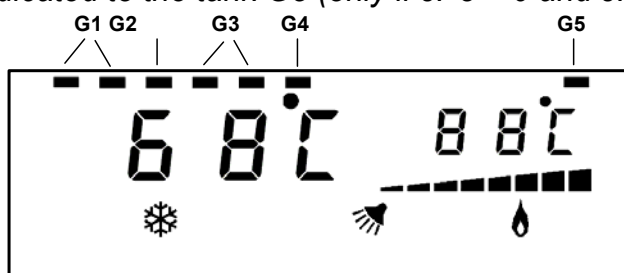

“Heating request”

When an heating request occurs, the temperature measured by the delivery probe is displayed and the symbol **III** starts to flash. On small digits you see the tank temperature. The instantaneous power of the boiler is indicated by the level of modulation. In any moment it is possible to observe which triac are turned on.

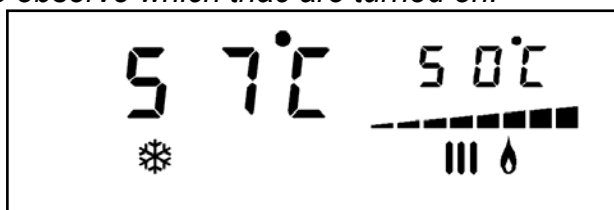

In case of boiler with heating only (JP 8 = 1) is only displayed the temperature of the primary exchanger.

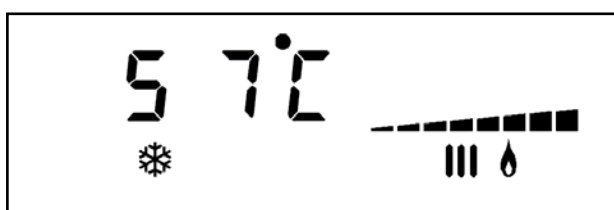



“Flow switch request (Comfort function)” (only if JP8=0)

When a flow switch request occurs, the temperature measured by the delivery probe is displayed and the symbol P start to flash. On small digits will show the temperature of the tank. The instantaneous power of the boiler is indicated by the level of modulation. In any moment it is possible to observe which triac are turned on.

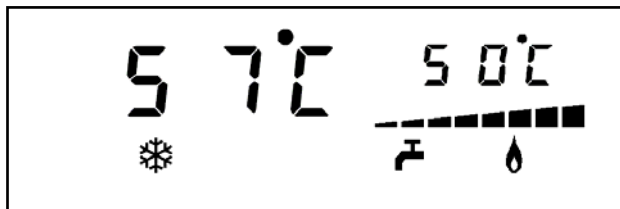

“Temperature display”

On the small digits will show "t : " followed by the description of the selected temperature while the big digit will show the temperature value.

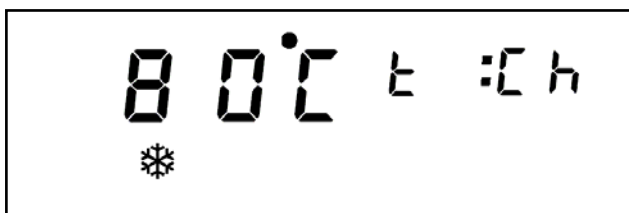

Function	Display
Delivery temperature	t :Ch
Tank temperature	t :dh
External temperature	t :EP
External probe offset setpoint	t :SE

“Parameters display”

Will show " P : " followed by the index of the selected parameter and the large value of the parameter.

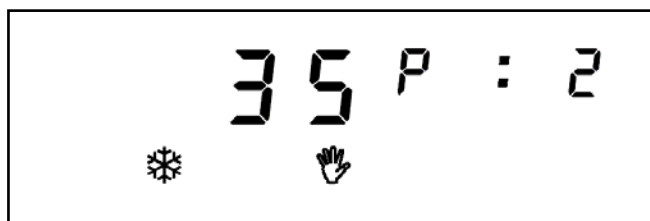

Visualization in the presence of a sanitary flow meter (P9=1)

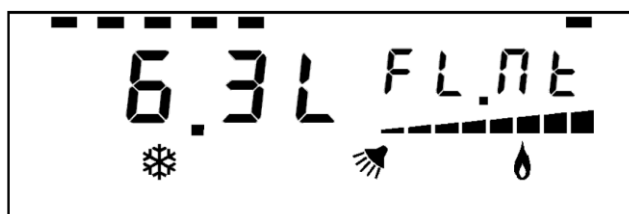



MALFUNCTIONING CODE

In the presence of anomalies shows " Err F X " where X is the corresponding error code.

Code "Err"	Meaning
F 9	Hardware EEPROM failure
F 1	Insufficient system water pressure
F 4	Tank probe error
F 3	Boiler delivery probe error
F 8	Safety thermostat block. To restore press the ON / OFF (J7) system

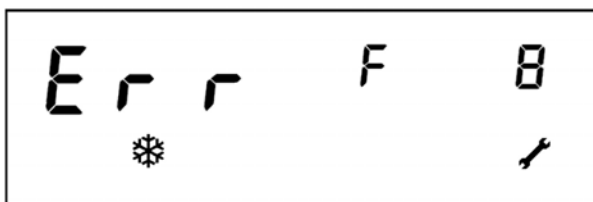

RESET OF THE APPARATUS (RESET)

To unlock the device, press the **ON / OFF (J7)** button which also has the "Reset" function.





FUNCTIONING WITH REMOTE CONTROL ENCRONO OT1 or OT2

Elektra Compact.. BP-L 016, can be connected by means of its board and an additional module to install on a prearranged part, to a compatible remote control device OpenTherm®, like Encrono OT1 or OT2. This can be obtained by means of the interface board (additional module). When the board finds the connection with the remote control, on the LCD display appears the symbol .

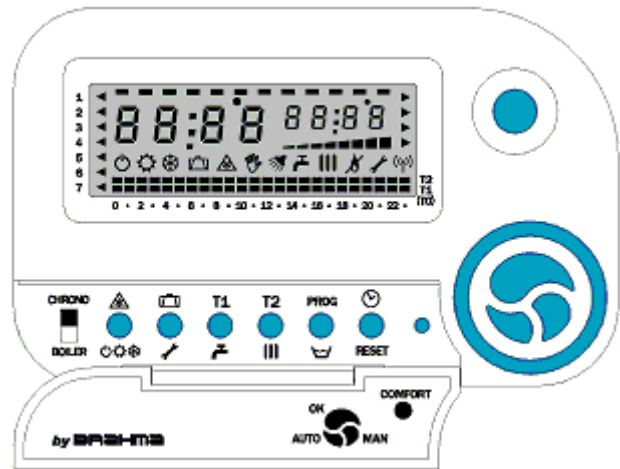

The compatible remote control OpenTherm becomes the master of the entire system, therefore almost all the functionalities, as the setting of heating and hot sanitary water set-point or the control of system status, are directly executable by it, in relation with the kind of application on which the board is used. By means of the remote control it is possible to restore (**RESET**) the system from the non-volatile lock status.

The communication between the remote control and the electronic board fitted with D.E.S. system can be interrupted in the following ways: Interruption of the connection between remote control and board: in this case, after 1 minute, the board starts to work in local mode.

Noise on communication cable between remote control and board: in this case it is possible that remote control and board do not manage to communicate (wrong data interpretation), therefore, after a certain lapse appears the related error signal. If the noise on the communication cable ends, the dialog between remote control and the board is automatically restored and the malfunction disappears.

TRANSPARENT PARAMETERS

This function is available only with the use of remote control OT2. The digital electronic PCB is equipped with 10 parameters adjustable by the installer, in order to set the functioning of the system in conformity to the final application. The parameters have the same meaning of the ones described in the table “parameters”.





RANGE OF SETPOINT ADJUSTABLE BY MEANS OF REMOTE CONTROL

<i>Interval of temperature setting with high temperature system (JP7 = 0)</i>	<i>30 °C ÷ 75 °C - step 1 °C Pre-set value: 60 °C</i>
<i>Interval of temperature setting with low temperature system (JP7 = 1)</i>	<i>15 °C ÷ 40 °C - step 1 °C Pre-set value: 30 °C</i>
<i>Temperature setting range internal tank or external with probe</i>	<i>30 °C ÷ 65 °C - step 1 °C Pre-set value: 60 °C</i>
<i>Instant DHW temperature setting range</i>	<i>30 °C ÷ 60 °C - step 1 °C Pre-set value: 50 °C</i>

FUNCTIONING OF BOILER ELEKTRA WITH REMOTE CONTROL





The actuation of heating mode takes place after an heating request from remote control (value of heating setpoint calculated by remote control higher than heating setpoint set by the user on remote control divided by two) and in the winter mode status. It also enabled the relay which controls the valve opening area managed by Enchrone.

HOT SANITARY WATER MODE (if only JP8 = 0)

The electric board of Elektra operates in the same way described previously. The setpoint is set by the user on the remote control. Through the Enchrone OT1/OT2 you can enable the ECO/COMFORT by pressing . When the ECO function is active, the temperature of sanitary and the symbol  is the alternating temperature. In the COMFORT mode, the temperature of the hot water circuit appears fixed only when there is a request by the micro sanitary.

CONTROL PANEL IN USER MODE

The pressure of one key/two keys activated the backlighting of LCD display.

Key	Function
- (J5)	<i>Disabled in Opentherm mode</i>
+ (J6)	<i>Disabled in Opentherm mode</i>
ON/OFF (J7)	<i>Unlock error of safety thermostat - exit temperature visualization</i>
MODE (J4)	<i>Disabled in Opentherm mode</i>
+III (J2)	<i>Disabled in Opentherm mode</i>
-III (J3)	<i>Disabled in Opentherm mode</i>
- +  (J5 + J6)	<i>Enabling of Eco/Comfort function (only if JP8 = 0 and P8 = 0)</i>



CONTROL PANEL IN TEMPERATURE MENU

The buttons have the same operation described in "Meaning of the keys of temperature menu".

CONTROL PANEL IN THE MENU PARAMETERS

The buttons have the same operation described in "Meaning of keys of parameters menu".

DISPLAY OF MALFUNCTIONS

Code "Err"	Meaning
F 009	Hardware EEPROM failure
F 001	Insufficient system water pressure
F 004	Tank probe error
F 003	Boiler delivery probe error
F 008	Safety thermostat block. To restore press the ON / OFF (J7) system

For further details related to remote controls series OT1 / OT2, please see the related technical specifications.



SPARE PARTS

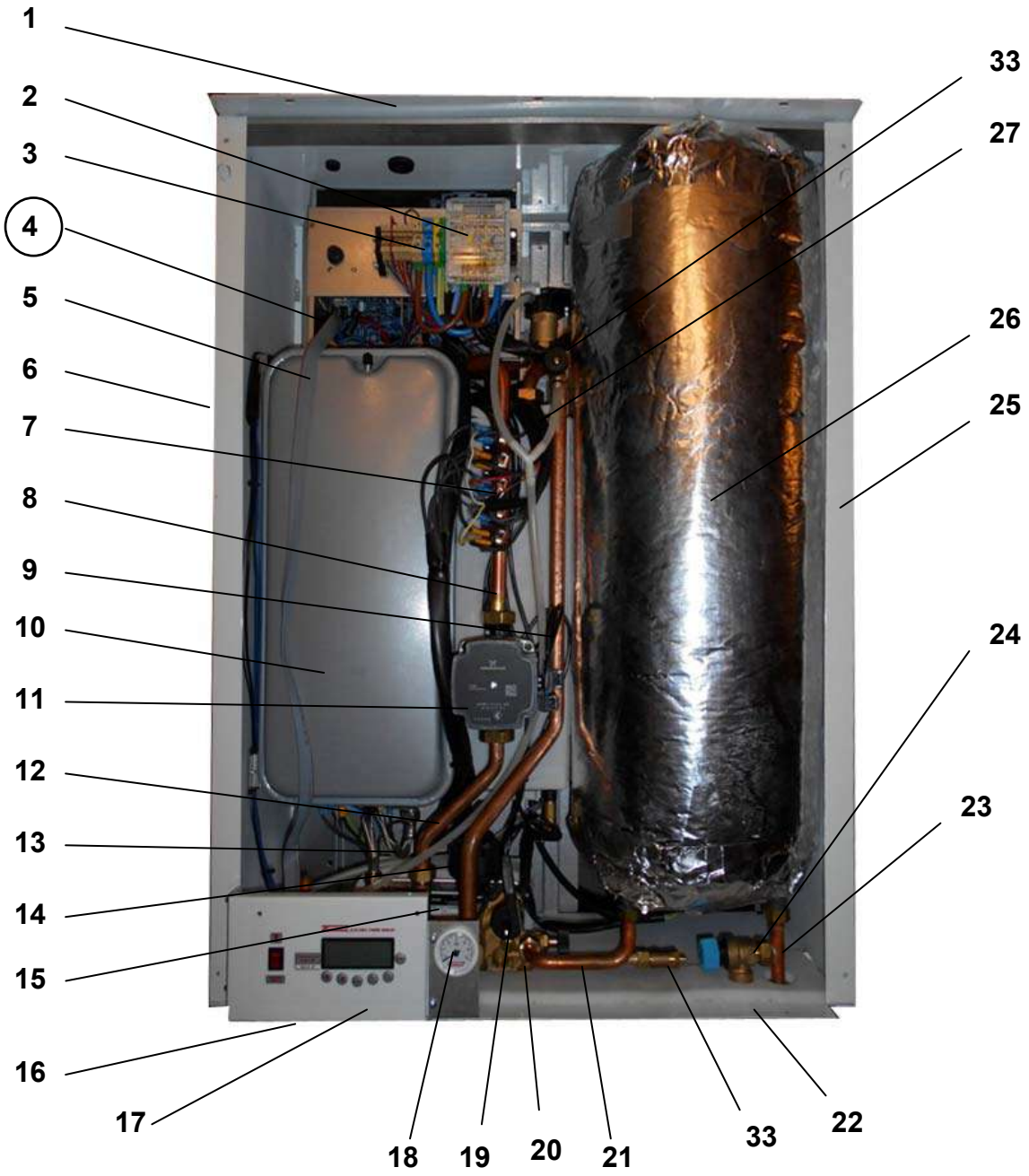

4 Particular

Particular : Boiler body / resistances

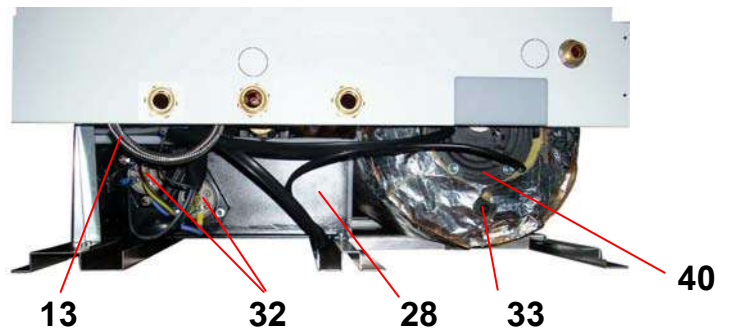
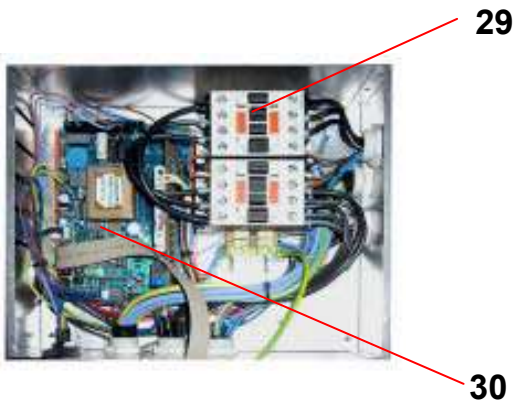



Upper particular / resistance

Front unit

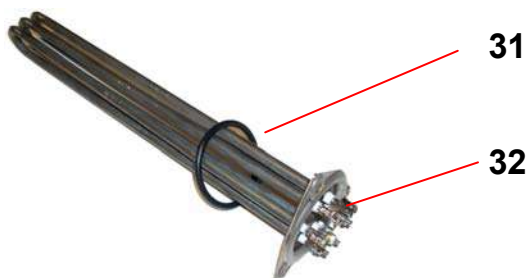

Particular: Flangelprobelresistancelanode group sanitary tank

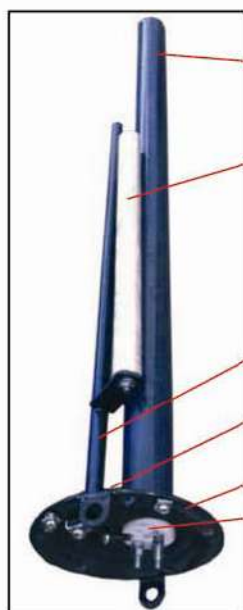

The group flange kettle, comprises in a single piece vitrified, both the sheath port probes, the sheath door heater and the support flange and inspection. Replacing the magnesium anode provides for the disassembly of the group. The replacement of the electric resistance does not provide for the emptying of the storage tank because inserted in a sealed sheath in vitrified steel.

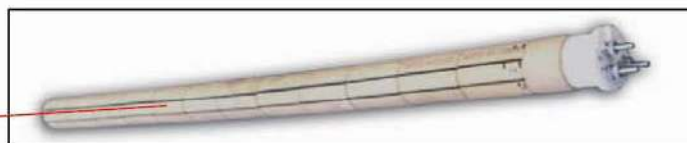



Spare parts - Legend

1	Upper closing fairing of Elektra.. B/BP-L.....	Cod.P.2025
2	Tetrapolar terminal block for Elektra 6/12/18	Cod.P.2054
	Tetrapolar terminal block for Elektra 24.....	
3	Terminal of the electric supply line 230-240 V (Ph).....	Cod.P.2073
	Terminal of the electric supply line 230-240 V (blue - N)	Cod.P.2072
	Terminal line of electrical ground (yellow/green).....	Cod.P.2074
4	General electric box (panel circuit board / contactor).....	
5	Flat cable connection LCD display.....	Cod.P0 7561
6	Left side panel of casing.....	Cod.P.2030
7	Triac of electric power (40 A - 600 V).....	Cod.P.2293
8	Return pump-boiler body tube	Cod.P.7808
9	Delivery pipe.....	Cod.P.7807
10	Expansion vessel 9 liters 12/18/24 kW version.....	Cod.P.7815
11	Circulator at variable prevalance (electronic pump).....	Cod.P.7326
12	Return tube.....	Cod.P.7802
13	Flexible tube for expansion vessel.....	Cod.P.1572
14	Diverter valve actuator	Cod.P.7735
15	Plate heat exchanger for Elektra C/BP 12 kW version.....	Cod.P.7810
16	Return group.....	Cod.P.7614
17	Heating safety valve 0,3 MPa (3 bar).....	Cod.P.158
18	Hydrometer.....	Cod.P.141
19	Water pressure switch (minimum pressure)	Cod.P.7623
20	Delivery group.....	Cod.P.7615
21	Inlet tube tank water	Cod.P.7816
22	Template connection pipes.....	Cod.P.7809
23	Outlet tube hot water tank (tank-dima).....	Cod.P.2036
24	Sanitary safety valve 0,65 MPa (6,5 bar).....	Cod.P.7540
25	Right side panel of casing	Cod.P.2029
26	Sanitary tank for Elektra.. B/BP.....	Cod.P.1999
27	Electrical wiring.....	Cod.P.7734
28	Body boiler Elektra 6 N/B/BP-L.....	Cod.F.1955
	Body boiler Elektra 12 N/C/B/BP-L.....	Cod.F.1955
	Body boiler Elektra 18 N/C/B/BP-L.....	Cod.F.1956
	Body boiler Elektra 24 N/C/B/BP-L.....	Cod.F.1957
29	PCB of operating Elektra N/C/B/BP.....	Cod.P.2057
30	Contactora of power for Elektra 6.....	Cod.P.2103
	Contactora of power for Elektra 12.....	Cod.P.2153
	Contactora of power for Elektra 18.....	Cod.P.2104
	Contactora of power for Elektra 24.....	Cod.P.2101
31	O-ring gasket for 3x2 kW electrical resistance for Elektra.....	Cod.P.2078
32	Electrical resistance 3x1 kW Elektra 6.....	Cod.P.7410
	Electrical resistance 3x2 kW Elektra 12/18/24.....	Cod.P.2718



33	<i>Drain tap ¼" for Elektra.. boiler/tank.....</i>	<i>Cod.P.7542</i>
34	<i>Contact safety thermostat 100°C Elektra.....</i>	<i>Cod.P.1195</i>
35	<i>Automatic bleed valve (jolly).....</i>	<i>Cod.P.7660</i>
36	<i>Front panel Elektra Compact.. BP-L.....</i>	<i>Cod.P.7813</i>
37	<i>Display Lcd (Lcd PCB).....</i>	<i>Cod.P.1763</i>
38	<i>Instrument panel of Elektra (profil+lexan keyboard P.2172).....</i>	<i>Cod.P.7548</i>
39	<i>Lighting general switch (on-off switch).....</i>	<i>Cod.P.1099</i>
40	<i>Flange/sheath probe support/sheath group for sanitary resistance... </i>	<i>Cod.P.2163</i>
41	<i>Magnesium anode Elektra B/BP-L.....</i>	<i>Cod.P.2165</i>
42	<i>Gasket flange Elektra.. B/BP-L.. tank.....</i>	<i>Cod.P.2166</i>
43	<i>Ceramic electric resistance 2 kW for sanitary tank.....</i>	<i>Cod.P.2167</i>

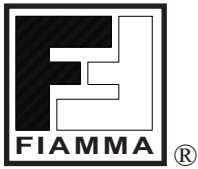

FIAMMA
GAS & ELECTRIC BOILER



**DICHIARAZIONE DI
 CONFORMITA'**



**DECLARATION OF
 CONFORMITY**

In accordo con - *According to:*

- 2006/95/EC** Direttiva Bassa Tensione (BT) – *Low Voltage Directive (LVD).*
- 2004/108/EC** Direttiva Compatibilità Elettromagnetica - *Electromagnetic compatibility Directive (EMC).*
- 2011/65/EU** Direttiva restrizione uso di determinate sostanze pericolose in apparecchiature elettriche ed elettroniche - *Directive on the restriction of use of certain hazardous substances (RoHS).*
- 1935/2004** Regolamento riguardante i materiali e gli oggetti destinati a venire a contatto con i prodotti alimentari – *Regulation on materials and articles intended to come into contact with food.*
- 2009/125/EC** Direttiva progettazione ecocompatibile dei prodotti connessi all'energia - *Ecodesign requirements for energy-related products (ErP).*

e successive modifiche - *and further amendments.*

N° di identificazione - <i>Identification No. :</i>	Vedi numero di matricola / <i>See the serial number</i>
Costruttore - <i>Manufacturer :</i>	FIAMMA GIRO s.r.l.
Indirizzo- <i>Address :</i>	via L. Landucci n°.2/B - 51100 PISTOIA ITALY
Telefono - <i>Telephone :</i>	(+39).0573.532812
Telefax – <i>Telefax :</i>	(+39).0573.532890
Tipo di apparecchio - <i>Type of equipment :</i>	Caldaia murale elettrica / <i>Electric wall boiler</i>
Marchio commerciale - <i>Trademark :</i>	 (dicitura FIAMMA / FIAMMA marked)
Tipo / Modello – <i>Type / Model :</i>	Vedi Modello su targhetta dati / <i>See the model in data code</i> ELEKTRA 6-12-18-24 .. <i>ELEKTRA 6-12-18-24 ..</i>

Le norme armonizzate o le specifiche tecniche (designazioni) che sono state applicate in accordo con le regole della buona arte in materia di sicurezza in vigore nella CEE sono :

The following harmonised standards or technical specifications (designations) which comply with good engineering practice in safety matters in force within the EEC have been applied :

Norme o altri documenti normativi
Standards or other normative documents
 EN 60335-2-21
 EN 62233
 EN 61000-3-11 ; EN 61000-3-12
 EN 55014-1 ; EN 55014-2

Rapporto di collaudo - Schede tecniche
Test report-Technical file
 Nr. AG14S0228076-01

Le caldaie della serie Elektra... sono certificate CB con documento n°.IT-16587.
The boilers of the Elektra series are CB certified with document number IT-16587.



In qualità di costruttore e/o rappresentante autorizzato della società all'interno della CEE, si dichiara sotto la propria responsabilità che gli apparecchi sono conformi alle esigenze essenziali previste dalle Direttive su menzionate.
As the manufacturer's authorised representative established within EEC, we declare under our sole responsibility that the equipment follows the provisions of the Directives stated above.

Pistoia, 01/10/2015

Giro Luca
 presidente consiglio di amministrazione
 Board Chairman of administration



SEDE: 51100 PISTOIA - ITALIA - Via L. Landucci, 2 z. i. - Tel. (+39).0573.532812 - Telefax: (+39).0573.532890. E-mail: fiammaPT@fiammagiro.it
 Cap. soc. € 40.000,00 Int. versato. - P.I.V.A. 01432870473 - R.E.A. 149197 - Albo Art. PT49948
 FILIALE: 37049 VILLA BARTOLOMEA (VR) - ITALIA - Via P. Bettini, 19 Z. I. Tel. (+39).0442.659028 - Telefax (+39).0442.659045
 E-mail : info@fiammagiro.it - fiammaVR@fiammagiro.it - ufficiotecnico@fiammagiro.it
 http\ : www.fiammagiro.com

official distributor for the United Kingdom (GB)



ABCOT UK Ltd.

Green Acres – Oakley Green Road – WINDSOR BERKSHIRE SL4 4QF.

Tel. 01628.636099 - 01628.676900 - Fax. 01628.676958 - E-mail: electricboilerscompany@mail.com

www.electriccombiboilerscompany.com

ELECTRIC   
COMBI BOILERS CO.

Fiamma

FIAMMA GIRO s.r.l. Company group



Sede legale e stabilimento: via L. Landucci n°.2/B - 51100 PISTOIA - ITALY

Tel.(+39).0573.532812 Fax.(+39).0573.532890 - E.mail: fiammaPT@fiammagiro.it

Filiale e stabilimento: via P. Bettini n° .19 - 37049 VILLA BARTOLOMEA (VR) - ITALY

Tel.(+39).0442.659028 Fax.(+39).0442.659045 - E-mail: fiammaVR@fiammagiro.it

www.fiammagiro.com