



*ELECTRIC COMBI WALL BOILER  
FOR HEATING AND SANITARY HOT WATER PRODUCTION  
INSTANTANEOUS  
Combi **Elektra Compact.. C 016 series***



## *USE AND MAINTENANCE MANUAL*



APPLIANCE COMPLIANT TO EC DIRECTIVE 2006/ 95/EC. Built and compliant with IEC 6 0335-1:2010 with EN 60335-2-21:2003+A1:2005+A2:2008 - EN 60335-1:2012 - EN 62233:2008





# **ELECTRIC WALL BOILER**

## **Series ELEKTRA Compact.. C 016**

### **Presentation**

*Thank you for choosing an electric wall boiler FIAMMA, built with the most modern technologies, safe and tough materials, so as to ensure maximum efficiency of use, total quality of the device and extreme safety for user. The series Elektra.. is built according to European standards dir. machines 2006/42 - IEC 60335-1:2010 with EN 60335-2-21:2003 +A1:2005+A2:2008 - EN 60335-1:2012 - EN 62233:2008.*

*The obtained results can be summarized in the following key points:*

- noiseless functioning, thanks to maximum insulation of the device by means of innovative special materials that ensures minimum heat loss.*
- high degree of reliability, thanks to a careful choice of materials and to server tests carried out during production for each unit built.*
- high performance with maximum efficiency, thanks to a modulation of electric power to the heating elements, according to the actual need of energy by the system or the need of sanitary water. The system D.E.S. manages the device with temperature probes positioned in each sensitive point of the boiler, so as to manage both comfort and economy functioning, in order to reduce power consumption when the device is not used at the maximum capacity or demand.*
- the appliance is fully adjustable both in water temperature of the heating system (with the possibility to choice of system at high and low temperature for the underfloor systems) and in the domestic hot water temperature.*
- The assembly of the components has been realized in order to allow an easy access to them, all from the front of the unit, for ordinary and extraordinary maintenance.*

*We recommend you to follow our instructions, and we suggest to contact the area authorized service FIAMMA in order to prepare a planned maintenance contract which can ensure suitable operation at maximum efficiency and safety, so that your machine use can go a long way. In renewing our thanks, our technical department and our sales network, are at your disposal for any further information.*

**FIAMMA GIRO s.r.l.**  
**Company group**



*The company FIAMMA GIRO s.r.l. declines all responsibility for possible inaccuracies contained in this pamphlet, if due to printing errors or inadvertent errors. However, reserves the right to make changes to its products that it deems useful or necessary, without affecting the essential characteristics of the products manufactured and marketed.*



## **WARNINGS:**



*THIS EQUIPMENT MAY BE USED BY CHILDREN FROM 8 YEARS AND UP TO PERSONS WITH CAPACITY PHYSICAL, SENSORY OR MENTAL CAPABILITIES OR LACK OF EXPERIENCE AND KNOWLEDGE, A CONDITION THAT SUPERVISION OR WHO WILL GET DIRECTIONS FOR USE IN THE DEVICE SAFELY TO UNDERSTAND THE RISKS INVOLVED. CHILDREN SHOULD NOT PLAY WITH THE APPLIANCE. CLEANING AND MAINTENANCE SHOULD NOT BE MADE BY CHILDREN WITHOUT SUPERVISION.*



*FOR DIRECT CONNECTION TO THE MAINS, YOU MUST PROVIDE A DEVICE THAT MAKE THE DISCONNECT THE NETWORK WITH A DISTANCE CONTACT OPENING ALLOWING THE COMPLETE DISCONNECT THE CONDITIONS OF OVERVOLTAGE CATEGORY III, UNDER THE RULES OF INSTALLATION.*



*IF THE POWER CABLE IS DAMAGED, IT MUST BE REPLACED BY THE MANUFACTURER OR THE TECHNICAL ASSISTANCE SERVICE OR OTHERWISE BY A PERSON WITH SIMILAR QUALIFICATION IN ORDER TO PREVENT ANY RISK.*



*WATER CAN DRIP FROM EXHAUST DEVICE AGAINST OVERPRESSURE AND THE HOSE MUST BE LEFT OPEN THE ATMOSPHERE.*



*THE DEVICE AGAINST OVERPRESSURE SHALL BE OPERATED REGULARLY TO REMOVE DEPOSITS OF LIMEST ONE AND TO CHECK THAT ARE BLOCKED.*



*THE EXHAUST PIPE CONNECTED TO THE DEVICE AGAINST OVERPRESSURE MUST BE INSTALLED IN SLOPE AND CONTINUE DOWN IN A PROTECTED BY ICE FORMATION.*



## DIMENSIONS

The series **Elektra Compact.. C 016** has three power levels, but the same overall dimensions:

**Elektra Compact 12 C 016** 12 kW maximum electrical output

**Elektra Compact 18 C 016** 18 kW maximum electrical output

**Elektra Compact 24 C 016** 24 kW maximum electrical output

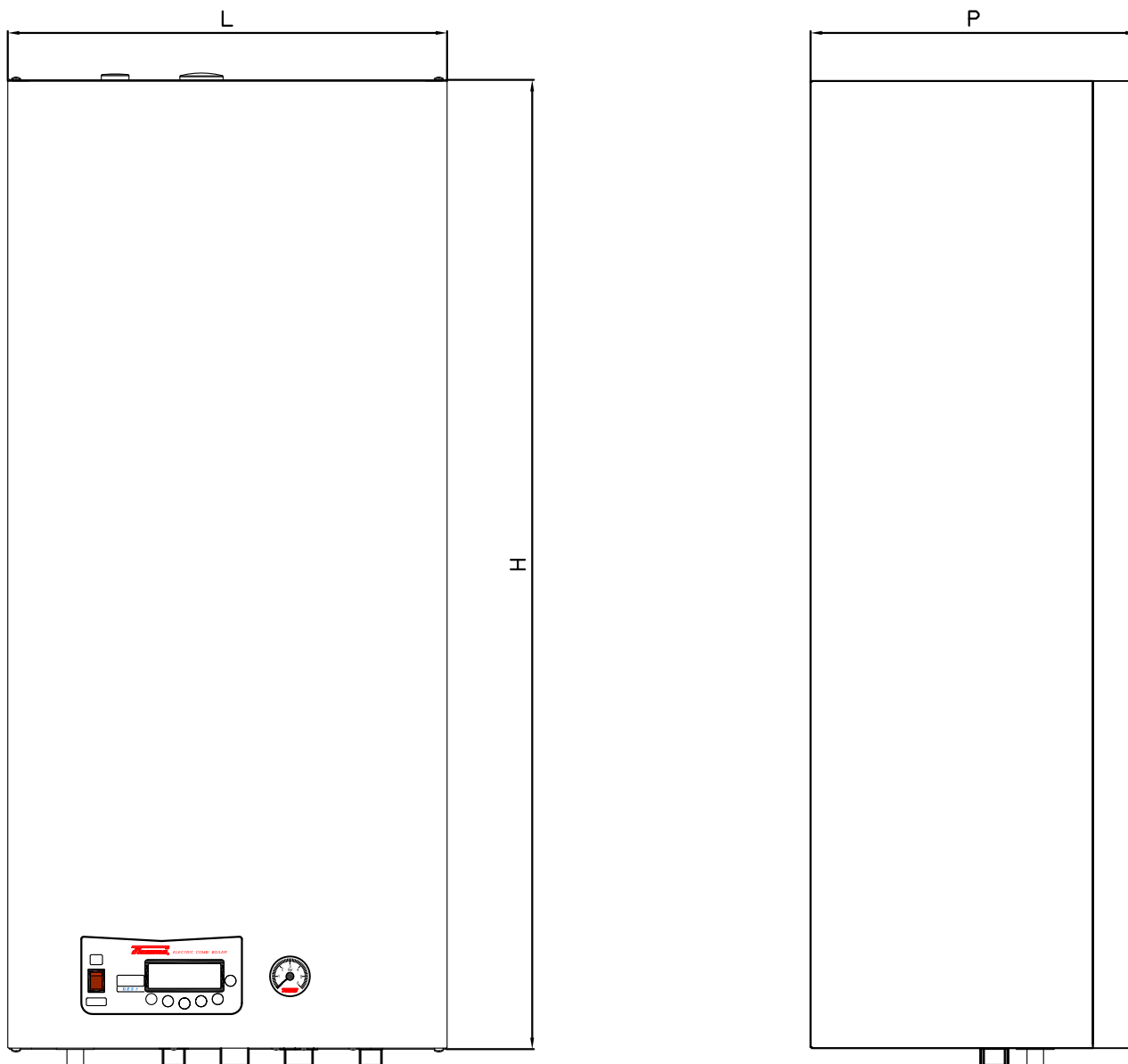

### Appliance dimension:

L (Width): 400 mm

H (Height): 875 mm

P (Depth): 300 mm

Weight: 39,5 kg

### Packaging dimensions:

Width: 440 mm

Height: 940 mm

Depth: 390 mm

Weight: 42 kg



### Hydraulic connections - Dimensional of connection arrangement

<b>M</b>	Heating delivery:	3/4" M
<b>R</b>	Heating return:	3/4" M
<b>AF</b>	Cold sanitary water inlet:	1/2" M
<b>AC</b>	Hot sanitary water output:	1/2" M
<b>VSR</b>	Heating safety valve (0,3 MPa - 3 bar):	1/2" F

The unit is expected to be connected in a continuous manner to the water mains without the use of a set of junctions.

Bottom view (under the boiler)

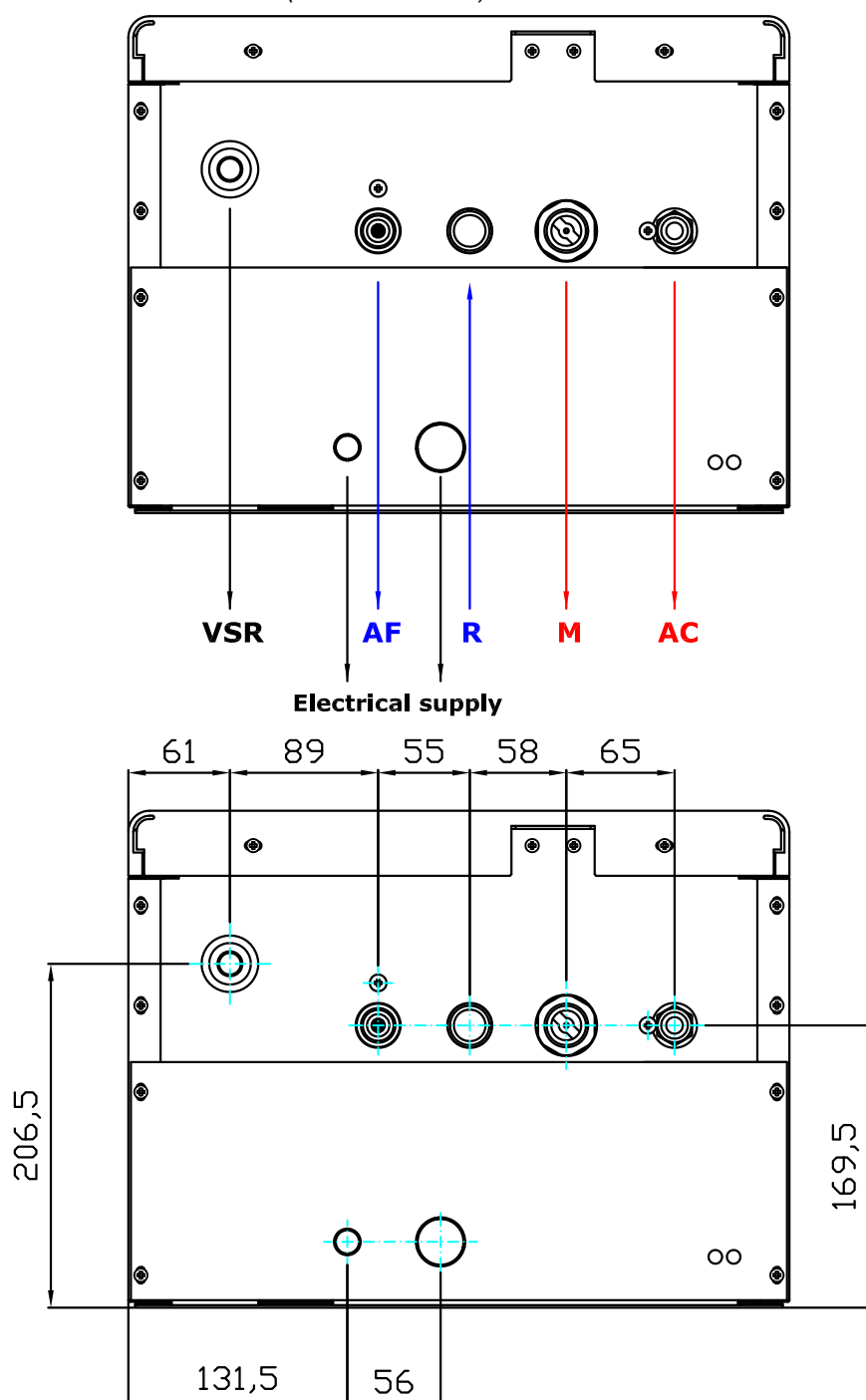



## **MAIN TECHNICAL FEATURES**

### **Elektra Compact 12 C 016 12 kW maximum electrical output**

*Single-phase electrical supply: 230-240 V - 50 Hz.*

*Weight: 39,5 kg*

*Electrical / heat power available at heating of 12 kW obtained by n°.2*

*Resistance group (n°.2 da 3x2 kW).*

*Maximum head available at the pump of 7 m.c.a.*

*Expansion vessel capacity of 10 liters.*

*Safety valve of heating circuit of 0,3 MPa (3 bar).*

*Maximum heating operating pressure: 0,25 MPa (2,5 bar).*

*Maximum sanitary operating pressure: 0,55 MPa (5,5 bar)*

*Minimum operating pressure in the heating circuit: 0,06 MPa (0,6 bar).*

*Mini. operating pressure in the sanitary, comfort system: 0,025 MPa (0,25 bar).*

*Min. op rating pressure in the sanitary, economy system: 0,005 MPa (0,05 bar).*

*Maximum limit of thermal safety heating circuit - boiler body: 100°C.*

### **Elektra Compact 18 C 016 18 kW maximum electrical output**

*Single-phase electrical supply: 230-240 V - 50 Hz.*

*Weight: 40,5 kg*

*Electrical / heat power available at heating of 18 kW obtained by n°.3*

*Resistance group (n°.3 da 3x2 kW).*

*Maximum head available at the pump of 7 m.c.a.*

*Expansion vessel capacity of 10 liters.*

*Safety valve of heating circuit of 0,3 MPa (3 bar).*

*Maximum heating operating pressure: 0,25 MPa (2,5 bar).*

*Maximum sanitary operating pressure: 0,55 MPa (5,5 bar)*

*Minimum operating pressure in the heating circuit: 0,06 MPa (0,6 bar).*

*Mini. operating pressure in the sanitary, comfort system: 0,025 MPa (0,25 bar).*

*Min. op rating pressure in the sanitary, economy system: 0,005 MPa (0,05 bar).*

*Maximum limit of thermal safety heating circuit - boiler body: 100°C.*



## **Elektra Compact 24 C 016 24 kW maximum electrical output**

Single-phase electrical supply: 230-240 V - 50 Hz.

Weight: 41,5 kg

Electrical / heat power available at heating of 24 kW obtained by n°.4

Resistance group (n°.4 da 3x2 kW).

Maximum head available at the pump of 7 m.c.a.

Expansion vessel capacity of 10 liters.

Safety valve of heating circuit of 0,3 MPa (3 bar).

Maximum heating operating pressure: 0,25 MPa (2,5 bar).

Maximum sanitary operating pressure: 0,55 MPa (5,5 bar)

Minimum operating pressure in the heating circuit: 0,06 MPa (0,6 bar).

Mini. operating pressure in the sanitary, comfort system: 0,025 MPa (0,25 bar).

Min. operating pressure in the sanitary, economy system: 0,005 MPa (0,05 bar).

Maximum limit of thermal safety heating circuit - boiler body: 100°C.

### **POSITIONING THE BOILER**

The appliance must be installed exclusively on a vertical and solid wall that can support the weight of the boiler through the support bracket placed supplied in the box packaging.

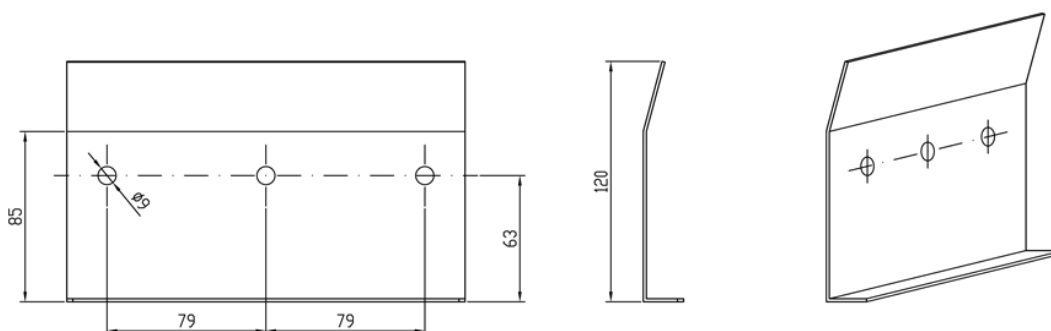

The bracket must be fixed to the wall with three M8 screws with appropriate anchors conform to the type of the wall itself (not in the boiler kit). The device is attached at the top by bringing the folded portion of the bracket in the chassis through the boiler behind the unit.





## CONTROL PANEL

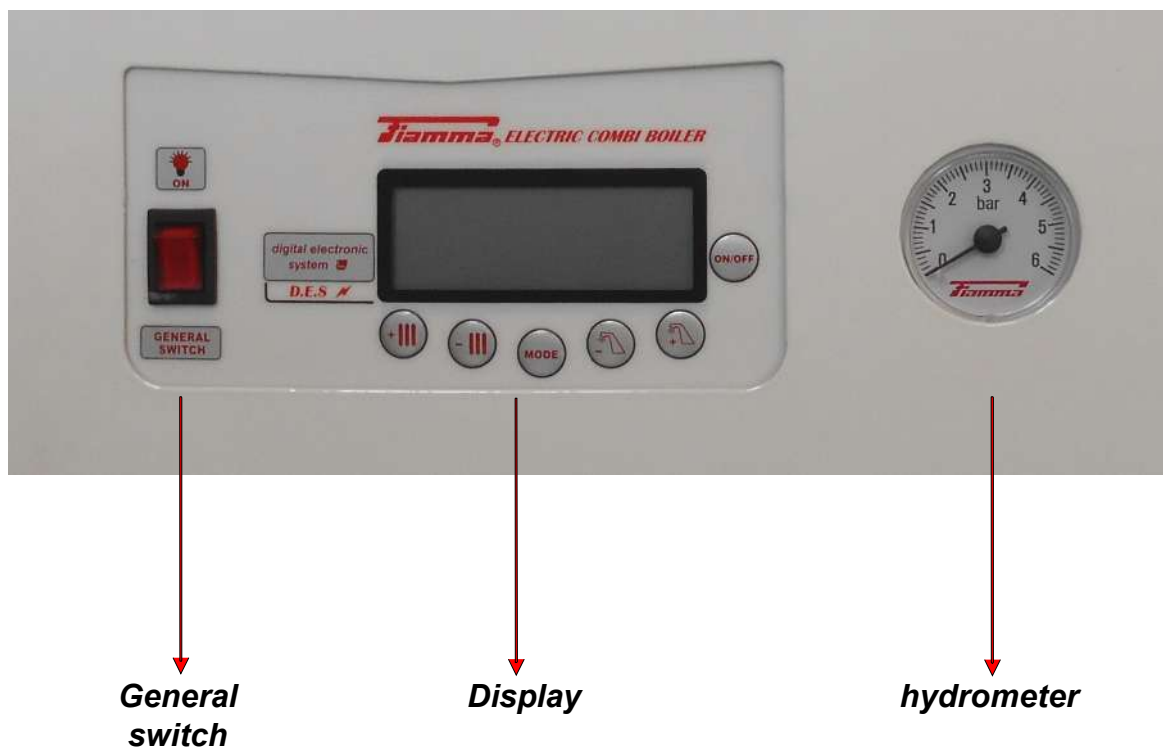

The control panel is composed of: display, function selection keys, general switch and the hydrometer it is placed in the lower left corner in front of the unit (see image above).

### **Using analogical hydrometer**

The analogical hydrometer control panel has a dial with unit of measure in a bar, by 0 to 6 bar. The water pressure in the heating system is indicated by the index of the black arrow. The optimum pressure for the system is between 1 and 1,5 bar.

More than 1,5 bar you can have a maximum pressure of the 2 bar (maximum expansion of the system during the rise in temperature). More than 2 bar pressure the system is not in the range of operation, and the mechanical safety valve (preset to 3 bar) can start to lose water (to access the valves remove the knockout openings at the valves, see page 2 hydraulic installation diagram).

The minimum operating pressure is 0,8 bar (+/-0,2 bar). The differential positive or negative tolerance is due to the operation of the water pressure switch with fixed setting.



## Keyboard panel (Control panel)

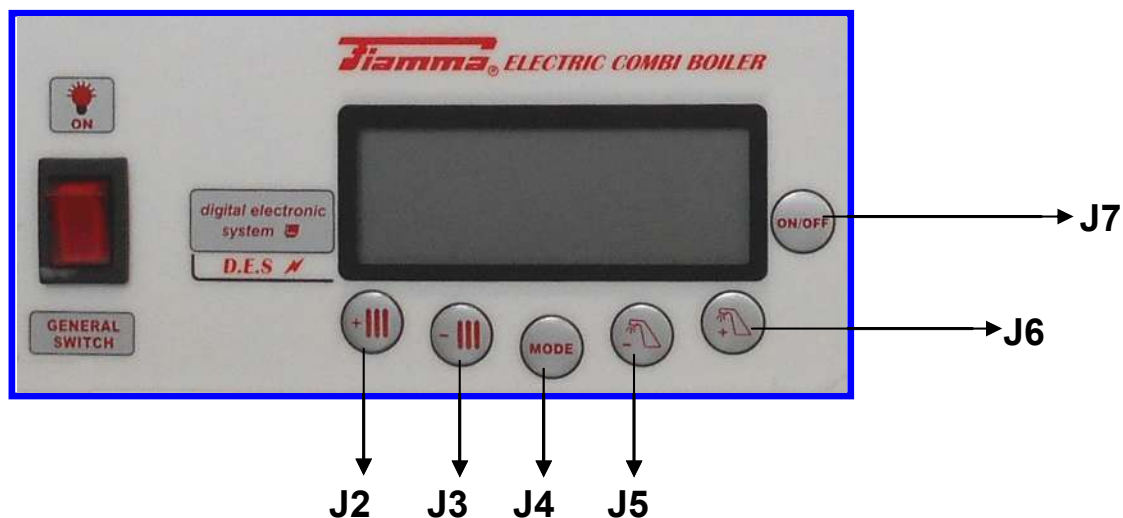

### Meaning of the keys in user mode

Key	Function
- III (J5)	Display / Sanitary setpoint decrease
+ III (J6)	Display / Sanitary setpoint decrease
ON/OFF (J7)	- ON - OFF switching (long press) - Display temperature output / Display setpoint output - Unlock error of safety thermostat
MODE (J4)	Summer - winter switching (long press)
+ III (J2)	Display / Increase of heating setpoint (or room temperature)
- III (J3)	Display / Decrease of heating setpoint (or room temperature)
- III + + III (J5 + J6)	Enabling function Eco/Comfort (only if JP8 = 0 and P8 = 0)
MODE + ON/OFF (J4 + J7)	Start function degassing



## **TURNING ON THE BOILER**

The boiler is switched-on by means of the general switch located on the left of the display in the instrument panel of the boiler. Pressing the switch upward to the ON position, it will light in the presence of single-phase supply (230-240 V - 50 Hz). Then, it shall be pressed the **ON-OFF (J7)** on the keypad to switch the power from stand-by to the operating position, the display will light up of blue and will appear various symbols signaling function/faults etc. At this point it shall be chosen the mode of operation, summer or winter operation.

## **CHOICE OF THE OPERATION MODE (Winter/Summer)**

Pressing the key **MODE (J4)**, it will be chosen the mode of operation, wintry or summery. Pressing repeatedly each time for at least 5 seconds, you switch from WINTER to SUMMER or from SUMMER to WINTER then.

When the device will be in WINTER mode, on the display will appear the Symbol ❄️ (snow). When the device will be in SUMMER mode, on the display will appear the Symbol ☀️ (sun).

## **TEMPERATURE VARIATION OF THE HEATING CIRCUIT**

When the apparatus has been set with the snow symbol (❄️) for the wintry functioning, you can change the maximum temperature of heating circuit pressing one of the two keys with the radiator symbol located on the left of the display ( +III and -III keys). The key with the symbol +III (J2), increases the temperature, and the key with the symbol -III (J3) decreases the temperature.

## **TEMPERATURE VARIATION OF HOT SANITARY WATER**

The temperature of hot sanitary water can be varied independently from the mode of functioning, both wintry and summery. The two keys with the Tap symbol on the left of the control panel, are used to set the maximum temperature of the hot sanitary water circuit. The key with Symbol +⚡ (J6) increases the temperature, and the one with the Symbol -⚡ (J5) decreases the temperature.



## ON-OFF KEY

### Display symbols

The **ON/OFF (J7)** key, in addition to put the boiler in stand-by mode, allows to reset (unlock) the apparatus in case of high temperature lock.

If the lock would be caused by lack of water pressure alarm, the recovery will be automatic

after that the hydric pressure will be restored at the minimum operating level (0,08 MPa - 0,8 bar) by means of the operating and the closure of the charging tap placed under the boiler (black handle). The display has several symbols, signaling in addition to operation modes, also the various alarm or system displays:



Symbol	Meaning
	Malfunction
	Request of burner switch-on
	Heating request
	Sanitary request (generic)
	Function sanitary Comfort activated
	Parameter menu activated
	Anti-freeze request activated
	Winter mode
	Summer mode
	OFF mode
<b>Level of modulation</b>	Indicates the instantaneous power of the boiler by 0 to 100%





# CONNECTING SCHEME

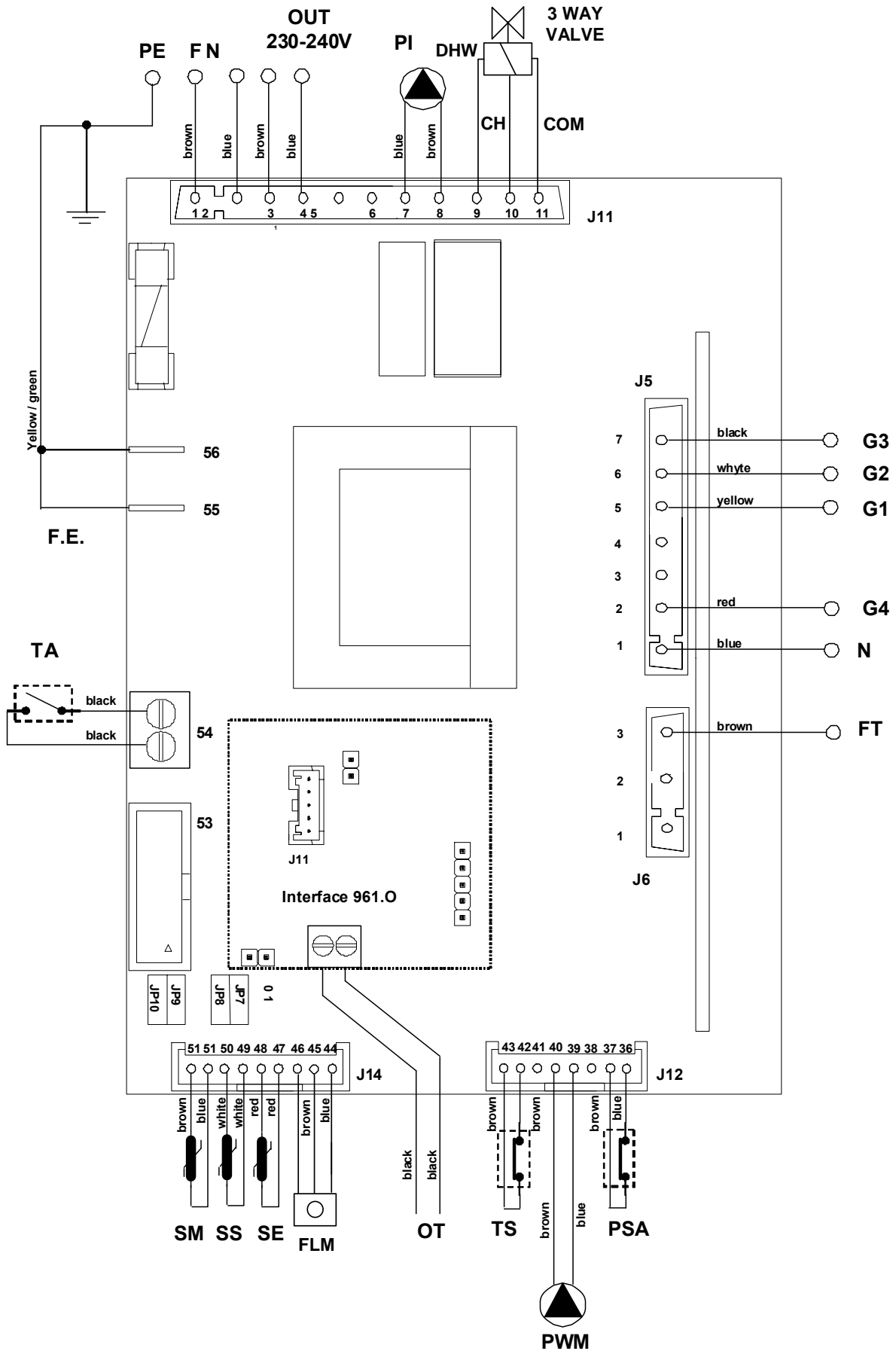



## MAIN ELECTRIC SCHEME

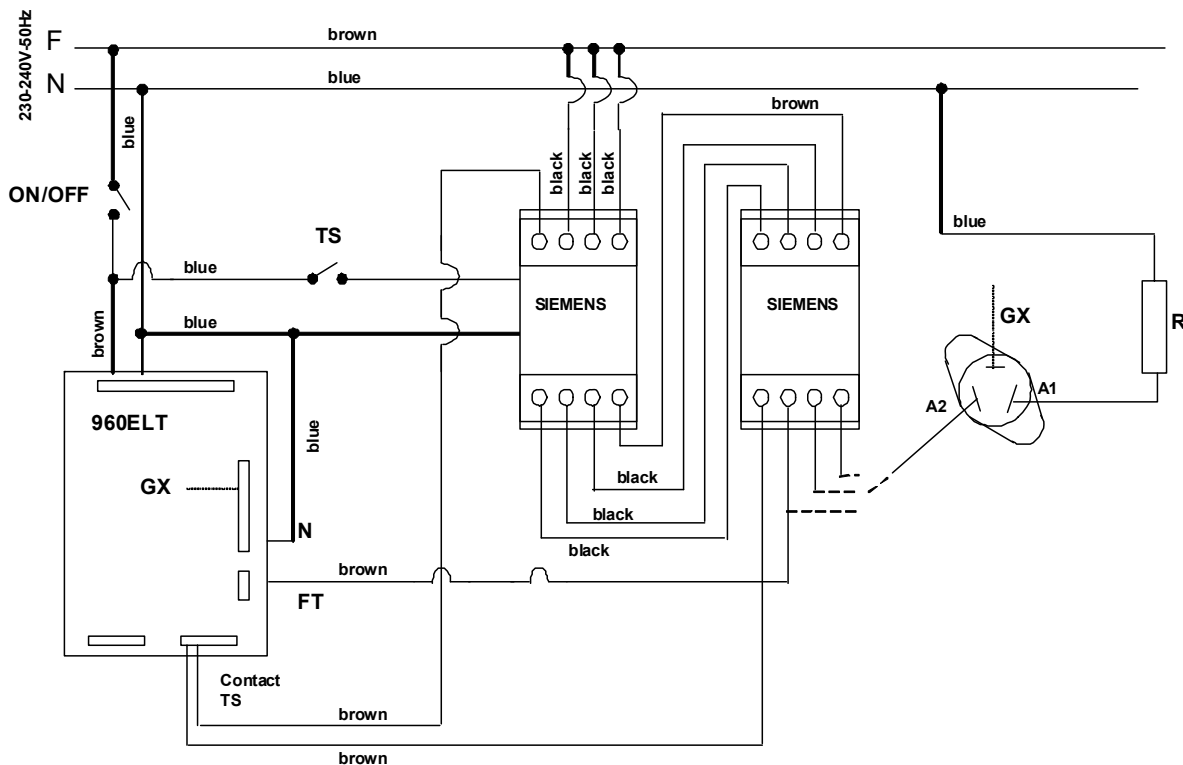

### Legend electric scheme

Single phase	<b>F</b>
Neutral	<b>N</b>
Selected phase from contactor	<b>FT</b>
Electric pump (circulator with variable head)	<b>PI</b>
Sanitary diverter valve control - Diverting valve control for heating	<b>DHW - CH</b>
Sanitary flow meter (control Comfort function)	<b>FLM</b>
Control gate triac n°1 (4 KW power)	<b>G1</b>
Control gate triac n°2 (2 KW power)	<b>G2</b>
Control gate triac n°3 (4 KW power)	<b>G3</b>
Control gate triac n°4 (2 KW power)	<b>G4</b>
Delivery heating probe (ntc sensor)	<b>SM</b>
External probe (sensor)	<b>SE</b>
Sanitary probe	<b>SS</b>
Water pressure switch	<b>PSA</b>
Safety thermostat	<b>TS</b>
Room thermostat (terminal provided)	<b>TA</b>
Connection with remote control OpenTherm (optional)	<b>OT</b>
General switch (Also disconnects power to the board)	<b>ON/OFF</b>
Functional ground derived from the point ground	<b>F.E.</b>
Properly grounded point this application	<b>PE</b>



# TRIAC – Connection scheme

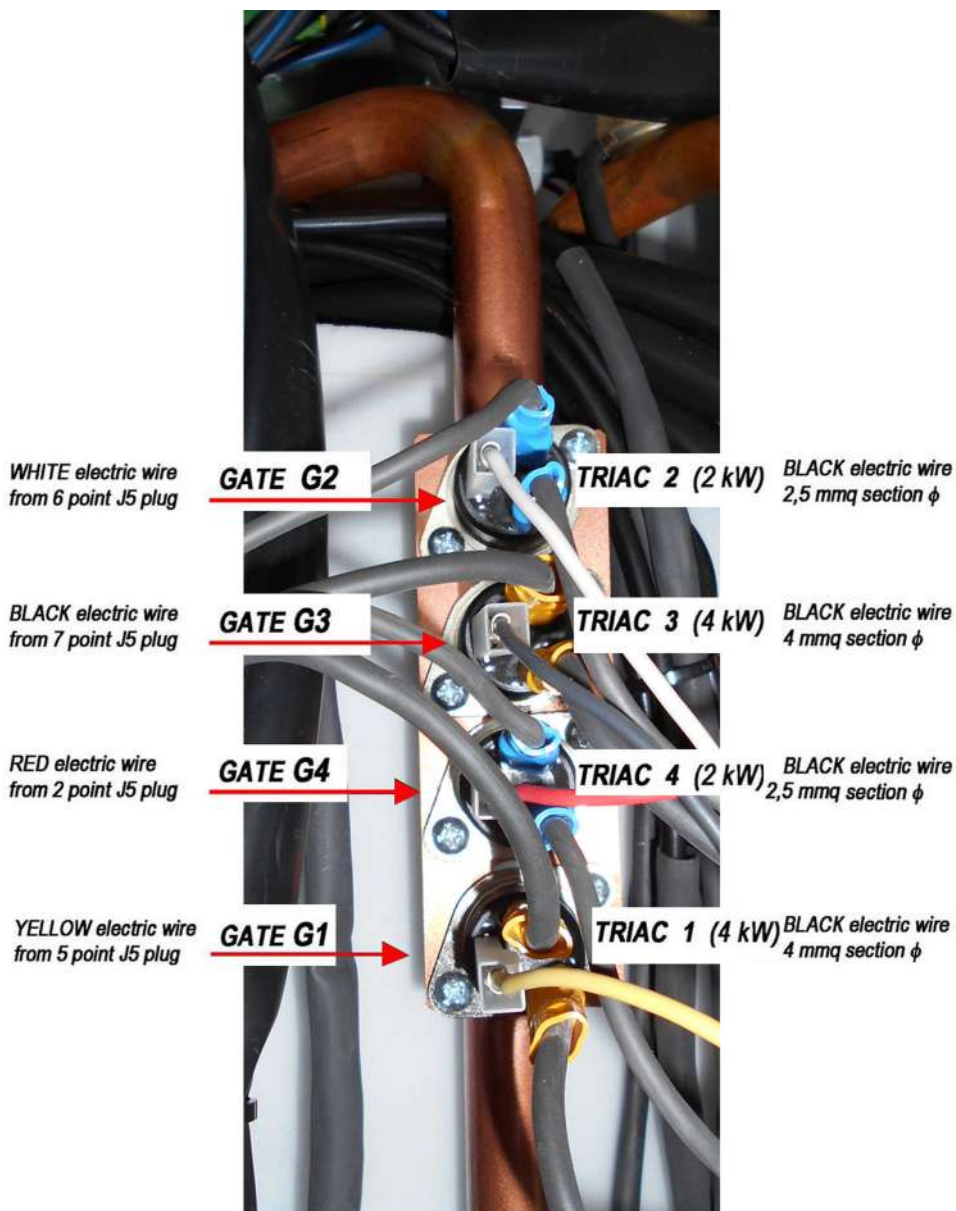
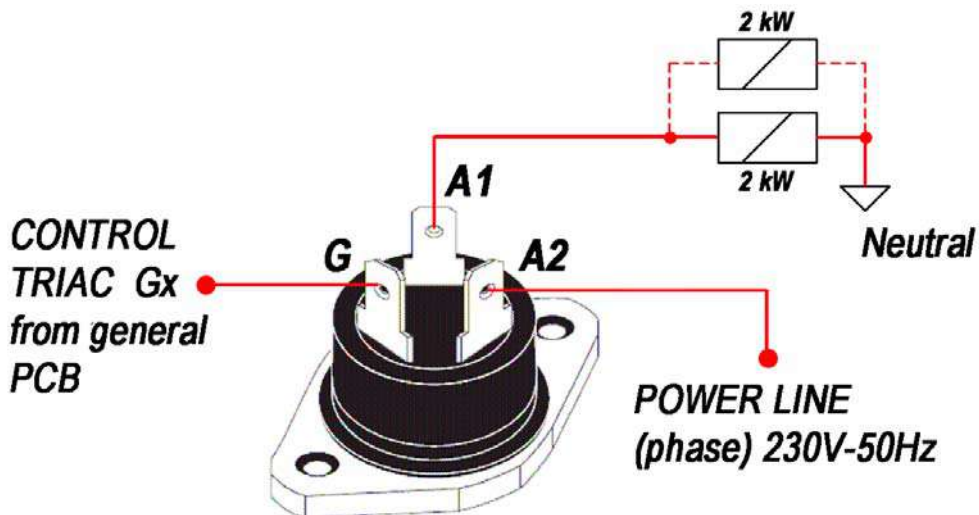





## MANUFACTURE CONSTANTS

Function	Value
Delta off sanitary probe	0 °C
Delta on sanitary probe	-1 °C
Maximum temperature primary circuit	80 °C
Time of pump functioning in anti-lock	10 sec
Intervention time anti-lock pump	24 ore
Temperature antifreeze On (only circulator)	< 8 °C
Temperature antifreeze On (heat exchanger ignition)	< 5 °C
Temperature antifreeze Off	> 20 °C

## SETPOINT AND PARAMETERS

Function	Default	Range
Heating setpoint	60 °C	30 ÷ 75 °C
Floor heating setpoint	30 °C	10 ÷ 40 °C
Room setpoint (with external probe present)	20 °C	10 ÷ 30 °C
Instantaneous DHW setpoint	50 °C	30 ÷ 60 °C

## PARAMETERS

Function	Display	Def.	Range
External probe start up	P : 1	0	0 – 1
Building coefficient of dispersion	P : 2	35	5 ÷ 35 °C
Sanitary post circulation	P : 3	15	1 ÷ 180 sec
Heating post circulation	P : 4	30	1 ÷ 180 sec
Heating exchanger circulation starting	P : 5	0	0 ÷ 240 sec
Min. ignition temperature circulator	P : 6	30	0 ÷ 50 °C
Delivery differential of sanitary	P : 7	15	0 ÷ 20 °C
Type kettle present	P : 8	0	0 = Internal probe 1 = External thermostat 2 = External probe
Type of sensor required	P : 9	1	0 = flow switch and three-way pneumatic 1 = flow meter and electric three-way
Speed pump PWM operation	P : 10	4	1 = 400 l/h 2 = 800 l/h 3 = 1.000 l/h 4 = 1.200 l/h



## TEMPERATURES

Function	Display
Delivery temperature	t :Ch
Hot water sanitary temperature	t :dh
External temperature	t :EP
Offset setpoint of external probe	t :SE
Sanitary flow meter flow rate expressed in liters/minute	FL.Πt

## SELECTION JUMPERS (move the jumpers with no power board)



Jumper	0	1	Default
JP7	High temperature (radiator)	Low temperature (floor)	0
JP8	Combined	Heating only	0
JP9	Sanitary with tank	Sanitary instantaneous	1
JP10	Boiler application	Scaldamassetto application	0

## CONTROL OF MAIN HEAT EXCHANGER (BOILER BODY)

According to the required power during the heat request, the controls by G1 to G4 related to the main exchanger are turned on all or partially. The actuation of each control is reduced to a lapse of 4 seconds. Higher is the required power, more the control will remain operative in this lapse. The power in heating or during a sanitary request is calculated by PID algorithm. Please see in the pictures below two examples related to 40% and 60% of total power (12 kW).

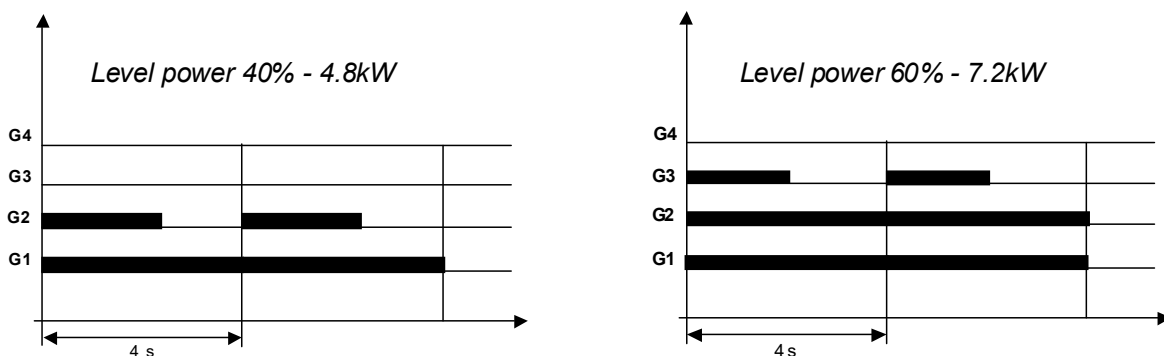

In case of simultaneous request of heating and tank, the controls G1÷G4 related to the main heat exchanger, will be directed in the following way:

Boiler status	Primary G1÷G4
Only sanitary request	G1 ÷ G4 = modulation
Heating request + flow meter request	G1 ÷ G4 = modulation



## Controls rotation

Every hour the order of ignition of triac G1÷G4 controls is rotated in such a way to partition evenly in time the use of all heating elements.

## CONTROL OF EXTERNAL PROBE

### Installation and functioning at sliding temperature

For the connection of the External Probe, it shall be used the Original Kit FIAMMA code F.532 provided in the accessories of the electric boilers Elektra. The electrical connection shall be done in the external terminal at the general electric panel already prearranged in the standard cabling of the boiler. The connection must be carried out with junction cables and wires having a minimum section of 1,5 mm and, if possible, avoiding the insertion along with electric lines, digital lines of inverter or other not compatible.



After the connection the external probe must be enabled by means of the introduction of a variation of **P1** parameter, changed from 0 to 1.

Then the setpoint chased by the heating delivery probe will be calculated as follows:

$$T_{ch} [^{\circ}\text{C}] = [( T_{room} [^{\circ}\text{C}] - T_{ext} [^{\circ}\text{C}] ) * dc/10 ] + T_{room} [^{\circ}\text{C}]$$

$T_{ch}$  : heating setpoint calculated by the system

$T_{room}$ : ambient temperature set by the user

$T_{ext}$ : outside temperature measured by the probe

**dc**: dispersion coefficient of the building can be set by parameter **P2**.

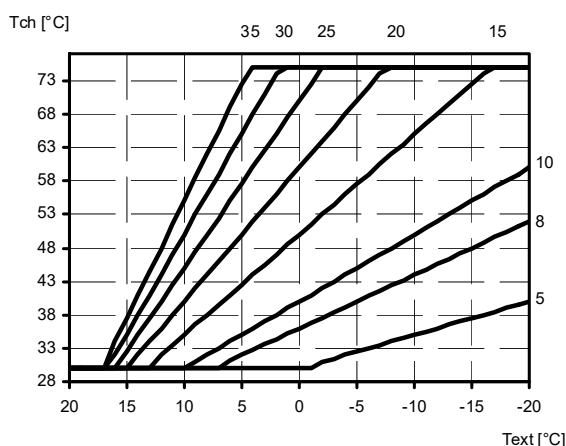

Examples of curves with  $T_{room}$  set at 20°C and JP7 = 0

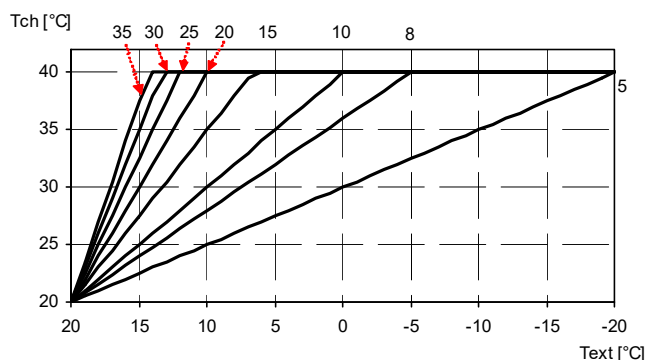

Examples of curves with  $T_{room}$  set at 20°C and JP7 = 1



### **ANTIFREEZE FUNCTION**

*In case the delivery probe measures a temperature lower than 7°C, the circulator is activated. If the temperature goes down the value of 4°C, the primary exchanger (boiler body) is turned on until bringing the outlet temperature to 20°C. The antifreeze function is active also with the boiler turned OFF (function in standby mode but with bright switch on).*

### **DHW DEMAND INSTANTANEOUS (jumper JP9 = 1)**

*When receiving a request by the sanitary flow switch, the circulator is powered and checks the commands G1, G2, G3, G4 relative to the primary exchanger bringing the supply temperature to the DHW set point + differential value set through parameter **P7**. At the end of the request, the circulator remains powered for a time equal to the value set by parameter **P3**. In the presence of an electric diverter, it's fed into position DHW (230V). At the end of post-circulation phase the diverter is activated for a short period in order to avoid blocking for long inactivity.*

### **FUNCTION ECONOMY / COMFORT SANITARY**

*In ECO mode in the stand-by condition no resistance of the primary exchanger is activated. When it is active the COMFORT function in stand-by conditions the primary exchanger is maintained in temperature in order to ensure a prompt response of sanitary. The main heat exchanger is maintained at a temperature equal to the DHW set point temperature plus a differential adjustable via the parameter **P7**.*

### **REQUEST HEATING**

*At the closing of the room thermostat contact, if the board is in winter mode, the system pump is only activated if the primary exchanger temperature is higher than the set temperature using the parameter **P6**. If the temperature value detected by the primary exchanger probe is lower than the flow temperature setpoint set, the triacs are turned on in sequence according to the power required. This only occurs after a time set by parameter **P5**, to allow for example the opening of eventual zone valves. The instantaneous power of the boiler and the control of the triac G1÷G4 is by PID controller. At the end of the request, the circulator remains powered for a time equal to the value set by parameter **P4**.*

### **ANTI-LOCK CIRCULATOR**

*If the circulator, has not performed any operation cycle in a period of time of 24 hours, it is activated for 10 seconds, in order to avoid long idle block. At the end of the post-circulation phase, activated following a request for domestic hot water, the electric diverter valve is powered for 2 seconds to avoid blocking for long periods of inactivity.*



## DEGASSING FUNCTION

During the degassing function activated by simultaneously pressing the **MODE (J4)** button and **ON / OFF (J7)**. During this function it is alternating operating states of maximum and minimum speed of the circulator PWM in order to facilitate the escape of air bubbles from the hydraulic circuit. The sequence is illustrated below. (When this function is active the display shows a timer that signals the time for the end of the function).

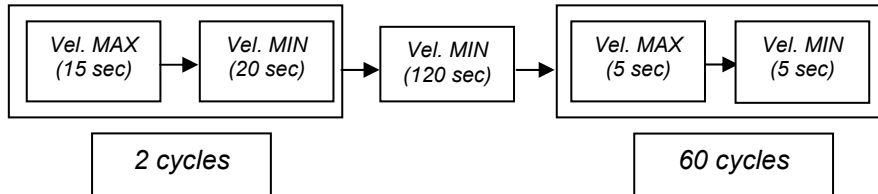

## INSTRUCTION GRUNDFOS PUMP UPM3 “K” FLEX-AS 2020 Version



	OPERATING PANEL	CONTROL MODE
0		PWM PROFILE A 1 - SIGNAL OFF
		PWM PROFILE A 1 - PWM SIGNAL ON
1		PWM PROFILE A 2 - SIGNAL OFF
		PWM PROFILE A 2 - PWM SIGNAL ON
2		PWM PROFILE A 3 - SIGNAL OFF
		PWM PROFILE A 3 - PWM SIGNAL ON

FLASH INDICATION	
	1 FLASH PER SECOND
	8 FLASHES PER SECOND

ALARM STATUS	FAULT
	BLOCKED
	LOW VOLTAGE
	ELECTRICAL ERROR

The new FLEX-AS (K) 2020 version pump, is equipped with three speeds that can be manually set, and 4 flow reductions (with speed lowering) via the PWM signal, which can be set from the boiler control display panel. In total, ten circulator speeds can be set with relative ten distinct flows.

### Pump programming

Manually select the maximum speed profile on key , then using the boiler control panel, select parameter 10 and choose one of the four available flows for each speed, setting values from 1 to 4. Set value 1 for the minimum flow, or 4 for the maximum flow, set 2 and / or 3 for the intermediate flow rates. According to the scheme of the table above, for each speed, the maximum value is represented by the Led that flashes once per second (parameter 10 setting to value 4), when the pwm programming intervenes, from value 3 to 1, the green Led flashes with a frequency of 8 flashes / second. The maximum speed is indicated by the first yellow Led under the III sign, the intermediate speed by the second yellow LED positioned under the II symbol, and the first speed is indicated by the third yellow LED under the I symbol (front view, from left to right).



### MEANING OF THE KEYS OF TEMPERATURE MENU

To log in temperature menu, press simultaneously **-||| (J3)** and **-⚡ (J5)** keys. The symbol  will appear on the display.

Key	Function
<b>ON/OFF (J7)</b>	Exit by temperature menu
<b>+    (J2)</b>	Temperature index increase
<b>-    (J3)</b>	Temperature index decrease

### MEANING OF KEYS OF PARAMETERS MENU

To log in parameter menu, press simultaneously **+||| (J2)** and **+⚡ (J6)** keys for 4 seconds. The symbol  will appear on the display.

Key	Function
<b>-⚡ (J5)</b>	Parameter value decrease
<b>+⚡ (J6)</b>	Parameter value increase
<b>ON/OFF (J7)</b>	Exit by parameters menu
<b>+    (J2)</b>	Parameter index increase
<b>-    (J3)</b>	Parameter index decrease

### “Heating elements status”

The dashes located in the upper part indicate the heating elements status. Each dash corresponds to a 2 kw element (with 12 kW application). The first 6 dashes refer to the heating modules of the primary exchanger.

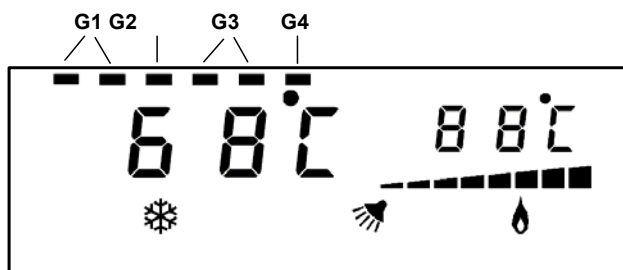

### “Heating request”

When an heating request occurs, the temperature measured by the delivery probe is displayed and the symbol **|||** starts to flash. On small digits you see the tank temperature. The instantaneous power of the boiler is indicated by the level of modulation. In any moment it is possible to observe which triac are turned on.

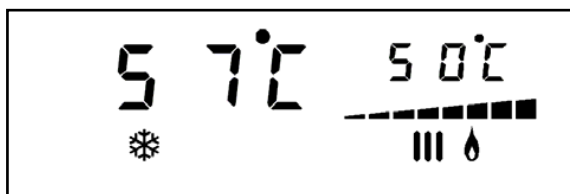

**"Getting sanitary microswitch" ECO mode (only with JP 8 = 0)**

When there is a request by the sanitary flow meter temperature is displayed measured by the flow sensor and the symbol  $\text{F}$  flashes. On small digits will show the temperature of the sanitary. The instantaneous power of the boiler is indicated by the modulation bar. And possible to see at any time what triac are on.

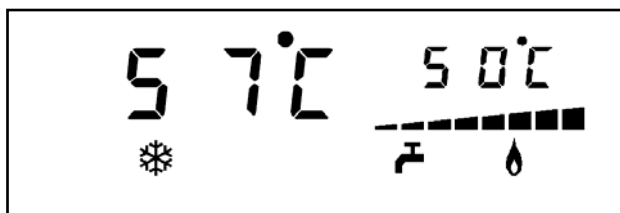

When there is a request by the sanitary microswitch in COMFORT mode, in addition to the above, the symbol appears on the display of the shower.

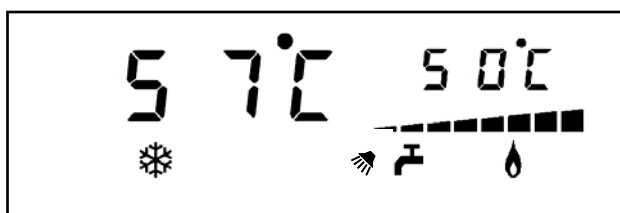

**"Temperature display"**

Will show "  $\text{t} :$  " followed by the index of the selected temperature and the large value of the temperature.

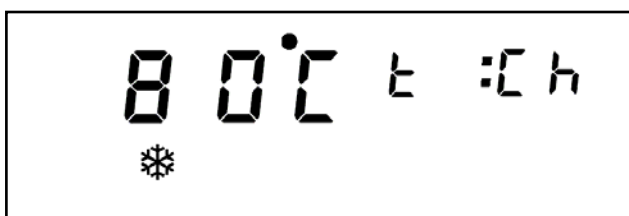

Function	Display
Delivery temperature	t :Ch
Sanitary temperature	t :dh
External temperature	t :EP
External probe offset setpoint	t :SE
Sanitary flow meter flow rate expressed in liters/minute	FL.πt





### “Parameters display”

Will show " P : " followed by the index of the selected parameter and the large value of the parameter.

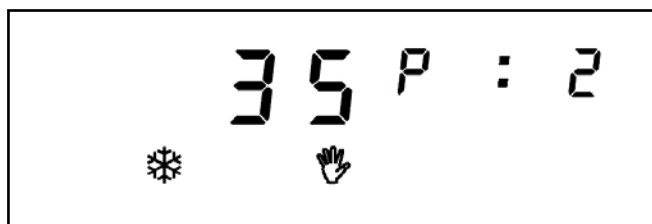

Visualization in the presence of a sanitary flow meter (P9=1)

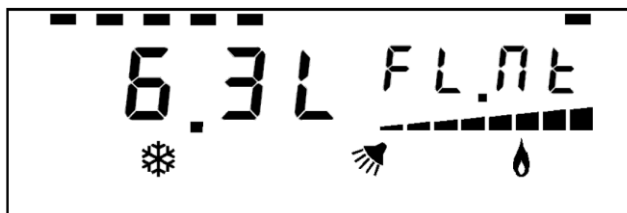

### MALFUNCTIONING CODE

In the presence of anomalies shows " Err F X " where X is the corresponding error code.

Code "Err"	Meaning
F 9	Hardware EEPROM failure
F 1	Insufficient system water pressure
F 4	Sanitary probe error
F 3	Boiler delivery probe error
F 8	Safety thermostat block. To restore press the ON / OFF (J7) system

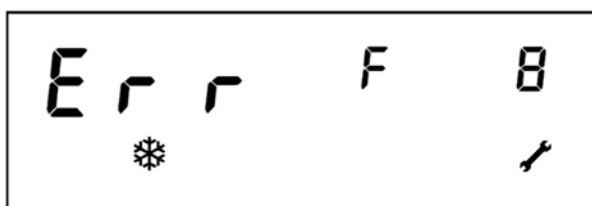

### RESET OF THE APPARATUS (RESET)

To unlock the device, press the ON / OFF (J7) button which also has the "Reset" function.







## FUNCTIONING WITH REMOTE CONTROL ENCRONO OT1 or OT2

**Elektra Compact.. C 016**, can be connected by means

of its board and an additional module to install on a prearranged part, to a compatible remote control device OpenTherm®, like Encrono OT1 or OT2. This can be obtained by means of the interface board (additional module). When the board finds the connection with the remote control, on the LCD display appears the symbol .

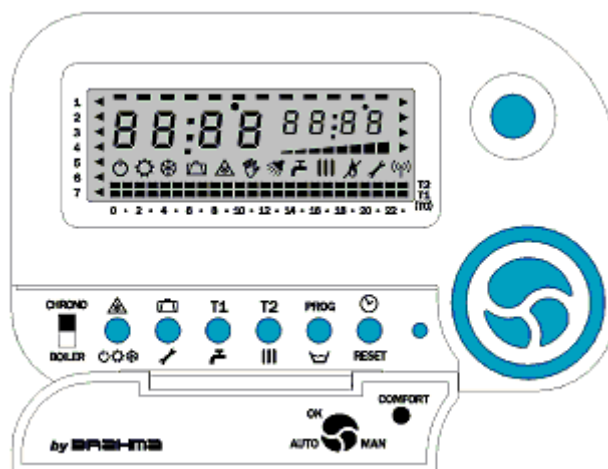

The compatible remote control OpenTherm

becomes the master of the entire system, therefore almost all the functionalities, as the setting of heating and hot sanitary water set-point or the control of system status, are directly executable by it, in relation with the kind of application on which the board is used. By means of the remote control it is possible to restore (**RESET**) the system from the non-volatile lock status.

The communication between the remote control and the electronic board fitted with D.E.S. system can be interrupted in the following ways: Interruption of the connection between remote control and board: in this case, after 1 minute, the board starts to work in local mode.

Noise on communication cable between remote control and board: in this case it is possible that remote control and board do not manage to communicate (wrong data interpretation), therefore, after a certain lapse appears the related error signal. If the noise on the communication cable ends, the dialog between remote control and the board is automatically restored and the malfunction disappears.

### TRANSPARENT PARAMETERS

This function is available only with the use of remote control OT2. The digital electronic PCB is equipped with 10 parameters adjustable by the installer, in order to set the functioning of the system in conformity to the final application. The parameters have the same meaning of the ones described in the table “parameters”.



## **RANGE OF SETPOINT ADJUSTABLE BY MEANS OF REMOTE CONTROL**

<i>Interval of temperature setting with high temperature system (JP7 = 0)</i>	<i>30 °C ÷ 75 °C - step 1 °C Pre-set value: 60 °C</i>
<i>Interval of temperature setting with low temperature system (JP7 = 1)</i>	<i>15 °C ÷ 40 °C - step 1 °C Pre-set value: 30 °C</i>
<i>Instant DHW temperature setting range</i>	<i>30 °C ÷ 60 °C - step 1 °C Pre-set value: 50 °C</i>

## **FUNCTIONING OF BOILER ELEKTRA WITH REMOTE CONTROL**

*The actuation of heating mode takes place after an heating request from remote control (value of heating setpoint calculated by remote control higher than heating setpoint set by the user on remote control divided by two) and in the winter mode status. It also enabled the relay which controls the valve opening area managed by Enchro.*

## **HOT SANITARY WATER MODE (if only JP8 = 0)**

*The electric board of Elektra operates in the same way described previously. The destre setpoint is set by the user on the remote control. Through the Enchro OT1/OT2 you can enable the ECO/COMFORT by pressing  $\sphericalangle$ . When the ECO function is active, the temperature of sanitary and the symbol  $\sphericalangle$  is the alt ernating temperature. In the COMFORT mode, the temperature of the hot water circuit appears fixed only when there is a request by t he micro sanitary.*

## **CONTROL PANEL IN USER MODE**

*The pressure of one key/two keys activated the backlighting of LCD display.*

<b>Key</b>	<b>Function</b>
<b>-<math>\sphericalangle</math> (J5)</b>	<i>Disabled in Opentherm mode</i>
<b>+<math>\sphericalangle</math> (J6)</b>	<i>Disabled in Opentherm mode</i>
<b>ON/OFF (J7)</b>	<i>Unlock error of safety thermostat - exit temperature visualization</i>
<b>MODE (J4)</b>	<i>Disabled in Opentherm mode</i>
<b>+III (J2)</b>	<i>Disabled in Opentherm mode</i>
<b>-III (J3)</b>	<i>Disabled in Opentherm mode</i>
<b>-<math>\sphericalangle</math> + +<math>\sphericalangle</math> (J5 + J6)</b>	<i>Enabling of Eco/Comfort function (only if JP8 = 0 and P8 = 0)</i>

## **CONTROL PANEL IN TEMPERATURE MENU**

*The buttons have the same operation described in "Meaning of the keys of temperature menu".*



## **CONTROL PANEL IN THE MENU PARAMETERS**

The buttons have the same operation described in "Meaning of keys of parameters menu".

## **DISPLAY OF MALFUNCTIONS**

<b>Code "Err"</b>	<b>Meaning</b>
<b>F 009</b>	<i>Hardware EEPROM failure</i>
<b>F 001</b>	<i>Insufficient system water pressure</i>
<b>F 004</b>	<i>Sanitary probe error</i>
<b>F 003</b>	<i>Boiler delivery probe error</i>
<b>F 008</b>	<i>Safety thermostat block. To restore press the <b>ON / OFF (J7)</b> system</i>

*For further details related to remote controls series OT1 / OT2, please see the related technical specifications.*

**SPARE PARTS**

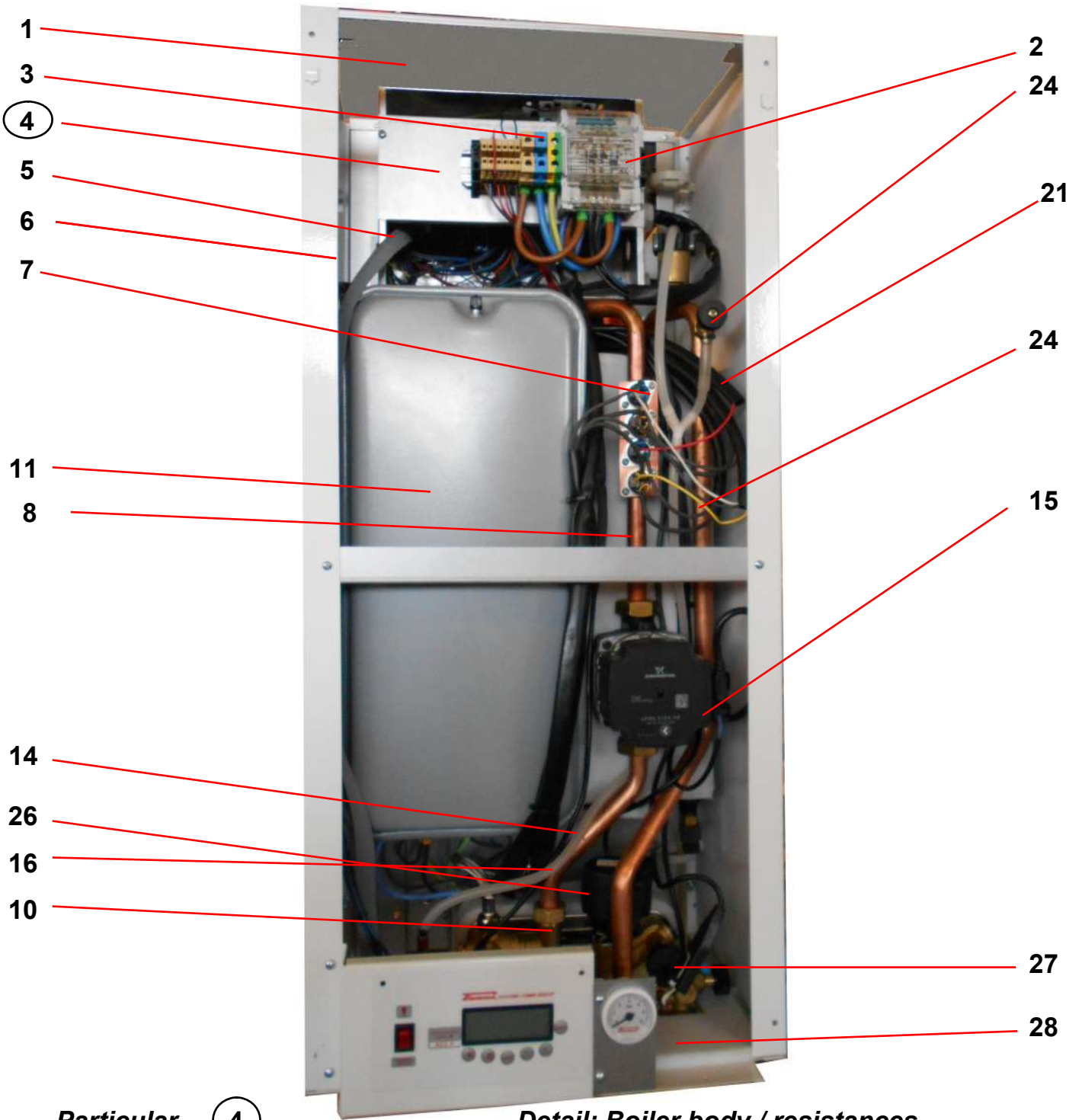

**Particular**

**4**

**Detail: Boiler body / resistances**

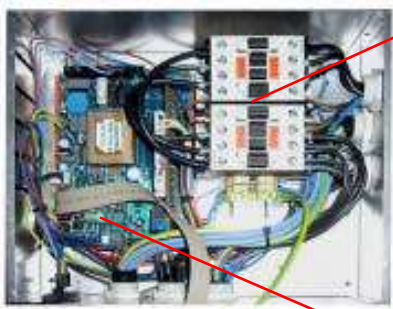

30

29

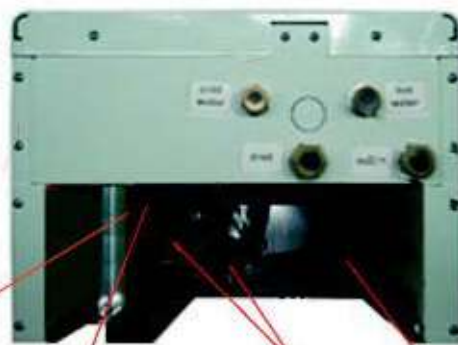

33

32

23



**Upper particular / resistance**

**Front unit**

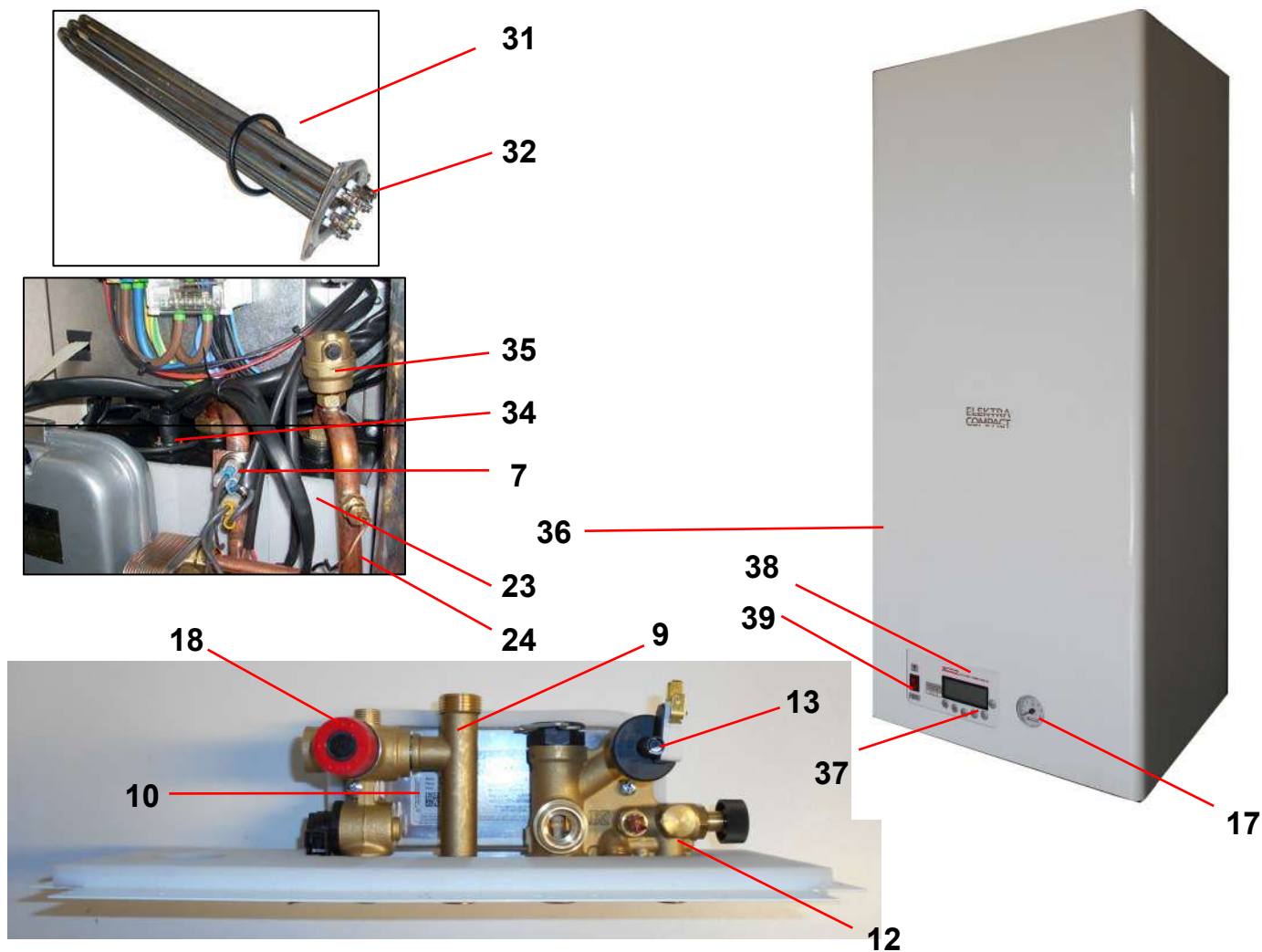

**Spare parts - Legend**

- 1 Upper closing fairing of Elektra.. C/N..... Cod.P.2127
- 2 Tetrapolar terminal block for Elektra 12/18..... Cod.P.2054
- 3 Terminal of the electric supply line 230-240 V (Ph)..... Cod.P.2073
- 4 Terminal of the electric supply line 230-240 V (blue - N)..... Cod.P.2072
- 5 Terminal line of electrical ground (yellow/green)..... Cod.P.2074
- 4 General electric box (panel circuit board / contactor).....
- 5 Flat cable connection LCD display ..... Cod.P.0 7561
- 6 Left side panel of casing ..... Cod.P.2030
- 7 Triac of electric power (40 A - 600 V)..... Cod.P.2293
- 8 Return tube heat exchanger-pump ..... Cod.P.7808
- 9 Cold water-return group..... Cod.P.7614
- 10 Plate heat exchanger for Elektra Compact.. 12 kW version..... Cod.P.7810
- Plate heat exchanger for Elektra Compact.. 18 kW version ..... Cod.P.7811
- Plate heat exchanger for Elektra Compact.. 24 kW version ..... Cod.P.7812



11	Expansion vessel 9 liters Elektra Compact C/BP-L.....	Cod.P.7815
12	Hot water-outlet-valve diverter group.....	Cod.P.7737
13	Water pressure switch (minimum pressure) .....	Cod.P.7623
14	Return pump-boiler body tube .....	Cod.P.7802
15	Circulator at variable prevalence (electronic pump).....	Cod.P.7326
16	Flexible tube for expansion vessel.....	Cod.P.1572
17	Hydrometer.....	Cod.P.141
18	Heating safety valve 0,3 MPa (3 bar).....	Cod.P.7602
20	Right side panel of casing .....	Cod.P.2029
21	Electrical wiring.....	Cod.P.7733
23	Body boiler Elektra Compact 12 C/BP-L.....	Cod.F.1955
	Body boiler Elektra Compact 18 C/BP-L.....	Cod.F.1956
	Body boiler Elektra Compact 24 C/BP-L.....	Cod.F.1957
24	Drain tap ¼” for Elektra.. boiler/tank .....	Cod.P.7542
26	Diverter valve actuator.....	Cod.P.7735
27	Lower panel (lower grid).....	Cod.P.2139
28	Template connection pipes .....	Cod.P.7800
29	PCB of operating Elektra Compact C/BP-L.....	Cod.P.2057
30	Contact of power for Elektra Compact 12.....	Cod.P.2153
	Contact of power for Elektra Compact 18.....	Cod.P.2104
	Contact of power for Elektra Compact 24.....	Cod.P.2101
31	O-ring gasket for 3x2 kW electrical resistance for Elektra.....	Cod.P.2078
32	Electrical resistance 3x2 kW Elektra 12/18/24.....	Cod.P.2718
33	Drain tap ¼” for Elektra.. boiler/tank.....	Cod.P.2190
34	Contact safety thermostat 100°C Elektra.....	Cod.P.1195
35	Automatic bleed valve (jolly).....	Cod.P.7660
36	Front panel Elektra Compact C.....	Cod.P.7801
37	Display Lcd (Lcd PCB).....	Cod.P.1763
38	Instrument panel of Elektra (profil+lexan keyboard P.2172).....	Cod.P.7548
39	Lighting general switch (on-off switch).....	Cod.P.1099



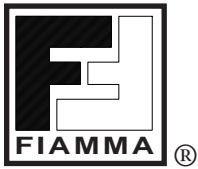

**FIAMMA**  
**GAS & ELECTRIC BOILER**



**DICHIARAZIONE DI  
 CONFORMITA'**



**DECLARATION OF  
 CONFORMITY**

In accordo con - *According to:*

- 2006/95/EC** Direttiva Bassa Tensione (BT) – *Low Voltage Directive (LVD).*
- 2004/108/EC** Direttiva Compatibilità Elettromagnetica - *Electromagnetic compatibility Directive (EMC).*
- 2011/65/EU** Direttiva restrizione uso di determinate sostanze pericolose in apparecchiature elettriche ed elettroniche - *Directive on the restriction of use of certain hazardous substances (RoHS).*
- 1935/2004** Regolamento riguardante i materiali e gli oggetti destinati a venire a contatto con i prodotti alimentari – *Regulation on materials and articles intended to come into contact with food.*
- 2009/125/EC** Direttiva progettazione ecocompatibile dei prodotti connessi all'energia - *Ecodesign requirements for energy-related products (ErP).*

e successive modifiche - *and further amendments.*

N° di identificazione - <i>Identification No. :</i>	Vedi numero di matricola / <i>See the serial number</i>
Costruttore - <i>Manufacturer :</i>	<b>FIAMMA GIRO s.r.l.</b>
Indirizzo- <i>Address :</i>	via L. Landucci n°.2/B - 51100 PISTOIA ITALY
Telefono - <i>Telephone :</i>	(+39).0573.532812
Telefax – <i>Telefax :</i>	(+39).0573.532890
Tipo di apparecchio - <i>Type of equipment :</i>	Caldaia murale elettrica / <i>Electric wall boiler</i>
Marchio commerciale - <i>Trademark :</i>	 (dicitura <b>FIAMMA / FIAMMA</b> marked)
Tipo / Modello – <i>Type / Model :</i>	Vedi Modello su targhetta dati / <i>See the model in data code</i> ELEKTRA 6-12-18-24 .. <span style="float: right;">ELEKTRA 6-12-18-24 ..</span>

Le norme armonizzate o le specifiche tecniche (designazioni) che sono state applicate in accordo con le regole della buona arte in materia di sicurezza in vigore nella CEE sono :

*The following harmonised standards or technical specifications (designations) which comply with good engineering practice in safety matters in force within the EEC have been applied :*

Norme o altri documenti normativi <i>Standards or other normative documents</i>	Rapporto di collaudo - Schede tecniche <i>Test report-Technical file</i>
EN 60335-2-21	Nr. AG14S0228076-01
EN 62233	
EN 61000-3-11 ; EN 61000-3-12	
EN 55014-1 ; EN 55014-2	

Le caldaie della serie Elektra... sono certificate CB con documento n°.IT-16587.  
*The boilers of the Elektra series are CB certified with document number IT-16587.*



In qualità di costruttore e/o rappresentante autorizzato della società all'interno della CEE, si dichiara sotto la propria responsabilità che gli apparecchi sono conformi alle esigenze essenziali previste dalle Direttive su menzionate.  
*As the manufacturer's authorised representative established within EEC, we declare under our sole responsibility that the equipment follows the provisions of the Directives stated above.*

Pistoia ,01/10/2015

**Giro Luca**  
 presidente consiglio di amministrazione  
 Board Chairman of administration



SEDE: 51100 PISTOIA - ITALIA - Via L. Landucci, 2 z. i. - Tel. (+39).0573.532812 - Telefax: (+39).0573.532890. E-mail: [fiammaPT@fiammagiro.it](mailto:fiammaPT@fiammagiro.it)  
 Cap. soc. € 40.000,00 Int. versato. - P.I.V.A. 01432870473 - R.E.A. 149197 - Albo Art. PT49948  
 FILIALE: 37049 VILLA BARTOLOMEA (VR) - ITALIA - Via P. Bettini, 19 Z. I. Tel. (+39).0442.659028 - Telefax (+39).0442.659045  
 E-mail : [info@fiammagiro.it](mailto:info@fiammagiro.it) - [fiammaVR@fiammagiro.it](mailto:fiammaVR@fiammagiro.it) - [ufficiotecnico@fiammagiro.it](mailto:ufficiotecnico@fiammagiro.it)  
 http\:\ www.fiammagiro.com

*official distributor for the United Kingdom (GB)*



**ABCOT UK Ltd.**

*Green Acres – Oakley Green Road – WINDSOR BERKSHIRE SL4 4QF.*

*Tel. 01628.636099 - 01628.676900 - Fax. 01628.676958 - E-mail: [electricboilerscompany@mail.com](mailto:electricboilerscompany@mail.com)*

[www.electriccombiboilerscompany.com](http://www.electriccombiboilerscompany.com)

**ELECTRIC**     
**COMBI BOILERS CO.**

***Fiamma***

**FIAMMA GIRO s.r.l. Company group**



Sede legale e stabilimento: via L. Landucci n°.2/B - 51100 PISTOIA - ITALY

Tel.(+39).0573.532812 Fax.(+39).0573.532890 - E.mail: [fiammaPT@fiammagiro.it](mailto:fiammaPT@fiammagiro.it)

Filiale e stabilimento: via P. Bettini n° .19 - 37049 VILLA BARTOLOMEA (VR) - ITALY

Tel.(+39).0442.659028 Fax.(+39).0442.659045 - E-mail: [fiammaVR@fiammagiro.it](mailto:fiammaVR@fiammagiro.it)

[www.fiammagiro.com](http://www.fiammagiro.com)